

# ***DUKANE***

## **LCD Projector Model 28A8711**





## **USER'S MANUAL**

Please read this user's manual thoroughly to ensure correct usage through understanding



## About the Symbols

Various symbols are used in this manual, the user's manual and on the product itself to ensure correct usage, to prevent danger to the user and others, and to prevent property damage. The meanings of these symbols are described below. It is important that you read these descriptions thoroughly and fully understand the contents.

	<b>Warning</b>	This symbol indicates information that, if ignored, could possibly result in personal injury or even death due to incorrect handling.
	<b>Caution</b>	This symbol indicates information that, if ignored, could result possibly in personal injury or physical damage due to incorrect handling.

## Typical Symbols



This symbol indicates an additional warning (including cautions). An illustration is provided to clarify the contents.



This symbol indicates a prohibited action. The contents will be clearly indicated in an illustration or nearby (the symbol to the left indicates that disassembly is prohibited).



This symbol indicates a compulsory action. The contents will be clearly indicated in an illustration or nearby (the symbol to the left indicates that the power plug should be disconnected from the power outlet).

**NOTE** : "Remote control transmitter" may be called "Remote controller" in the "USER'S MANUAL".

# SAFETY PRECAUTIONS

## WARNING

### **Never use the projector if a problem should occur.**

Abnormal operations such as smoke, strange odor, no image, no sound, excessive sound, damaged casing or elements or cables, penetration of liquids or foreign matter, etc. can cause a fire or electrical shock.

In such case, immediately turn off the power switch and then disconnect the power plug from the power outlet. After making sure that the smoke or odor has stopped, contact your dealer. Never attempt to make repairs yourself because this is dangerous this could be dangerous.

\* The power outlet should be close to the projector and easily accessible.



Disconnect the plug from the power outlet.

### **Do not insert liquids or foreign object.**

Penetration of liquids or foreign objects could result in fire or electrical shock. Use special caution in households where children are present.

If liquids or foreign object should enter the projector, immediately turn off the power switch, disconnect the power plug from the power outlet and contact your dealer.

\* Do not place the projector in a bathroom.

\* Do not expose the projector to rain or moisture.

\* Do not place flower vases, pots, cups, cosmetics, liquids such as water, etc on or around the projector.

\* Do not place metals, combustibles, etc on or around the projector.



### **Never modify.**

The projector contains high voltage components. Modification could result in fire or electrical shock.

\* Never open the cabinet.

\* Ask your dealer to repair and clean insider.



Do not disassemble.

### **Do not give the projector any shock or impact.**

If the projector should be shocked and/or broken, it could result in an injury, and continued use could result in fire or electrical shock.

If the projector is shocked, immediately turn off the power switch, disconnect the power plug from the power outlet and contact your dealer.



### **Do not place the projector on an unstable surface.**

If the projector should be dropped and/or broken, it could result in an injury, and continued use could result in fire or electrical shock.

\* Do not place the projector on an unstable, slant or vibrant surface such as a wobbly or inclined stand.

\* Use the caster brakes placing the projector on a stand with casters.

\* Do not place the projector in the side up position, the lens up position or the lens down position.





# SAFETY PRECAUTIONS (continued)

## WARNING

### **Be cautious of High temperatures of the projector.**

High temperatures are generated when the lamp is lit. It could result in fire or burn. Use special caution in households where children are present.

Do not touch about the lens, air fans and ventilation openings during use or immediately after use, to prevent a burn. Take care of ventilation.

\* Keep a space of 30 cm or more between the sides and other objects such as walls.

\* Do not place the projector on the metallic table.

\* Do not place anything about the lens, air fans and ventilation openings of the projector.

\* Never block the air fan and ventilation openings.

\* Do not use with the ventilation opening facing downwards.

\* Do not cover the projector with a tablecloth, etc.

\* Do not place the projector on a carpet or bedding.



### **Never look through the lens or openings when the lamp is on.**

The powerful light could adversely affect vision. Use special caution in households where children are present.



### **Use only the correct power outlet.**

Incorrect power supply could result in fire or electrical shock. Use only the correct power outlet depending on the indication on the projector and the safety standard.

\* The enclosed power cord must be used depending on the power outlet to be used.



### **Be cautious of the power cord connection.**

Incorrect connection of the power cord could result in fire or electrical shock.

\* Do not touch the power cord with a wet hand.

\* Check that the connecting portion of the power cord is clean (with no dust), before using. Use a soft and dry cloth to clean the power plug.

\* Insert the power plug into a power outlet firmly. Avoid using a loose, unsound outlet or contact failure.



### **Be sure to connect with ground wire.**

When you fix this unit with a metal tool and the like, you must connect it with ground wire; otherwise, fire or electric shock can result.

Connect the ground terminal of AC inlet of this unit with the ground terminal provided at the building using an optional three-core power-supply cord.



Connect the ground wire

# SAFETY PRECAUTIONS (continued)

---

## WARNING

### **Be careful in handling the the light source lamp.**

Incorrect handling the lamp could result in explosion.

- \* Since the lamp is made of glass, do not apply shock to it and not scratch it.
- \* When replacing lamp, turn off and remove AC cord, waite 45 minutes to let lamp cool. High-pressure lamp when hot, may explode if improperly handled.
- \* The lamp has a service life. For details, read the user's manual. Please contact your dealer or service company for replacement. Do not use old use old lamp. This could also cause explosion of the lamp.



### **Be careful in handling the power cord and external connection cables.**

If you keep using a damaged the power cord or cables, it can cause a fire or electrical shock. Do not apply too much heat, pressure or tension to the power cord and cables.

If the power cord or cables is damaged (exposed or broken core wires, etc.), contact your dealer.

- \* Do not place the projector or heavy objects on the power cord and cables. Also, do not place a spread, cover, etc, over them because this could result in the inadvertent placing of heavy objects on the concealed power cord or cables.
- \* Do not pull the power cord and cables. When connecting and disconnecting the power cord or cables, do it with your hand holding the plug or connector.
- \* Do not place the cord near the heater.
- \* Avoid bending the power cord sharply.
- \* Do not attempt to work on the power cord.



### **Be careful in handling the battery of the remote control transmitter.**

Incorrect handling of the battery could result in fire or personal injury. The battery may explode if not handled properly.

- \* Keep the battery away from children and pets. If swallowed consult a physician immediately for emergency treatment.
- \* Do not allow the battery in a fire or water.
- \* Avoid fire or high-temperature environment.
- \* Do not hold the battery with the metallic tweezers.
- \* Keep the battery in a dark, cool and dry play.
- \* Do not short circuit the battery.
- \* Do not recharge, disassemble or solder the battery.
- \* Do not give the battery a physical impact.
- \* Use only the battery specified in the user's manual.
- \* Make sure the plus and minus terminals are correctly aligned when loading the battery.
- \* If you observe a leakage of the battery, wipe out the flower and then replace the battery. If the flower adheres your body or clothes, rinse well with water.
- \* Obey the local laws on disposing the battery.



# SAFETY PRECAUTIONS (continued)

## CAUTION

### **Be careful in moving the projector.**

Neglect could result in an injury or damage.

- \* Do not move the projector during use. Before moving, disconnect the power cord and all external connections, and close the slide lens door.
- \* Avoid any impact or shock to the projector.
- \* For carrying, use the enclosed carrying bag if provided, depending on the manual of the carrying bag.



ENGLISH

### **Do not put anything on top of the projector.**

Placing anything on the projector could result in loss of balance or falling, and cause an injury or damage. Use special caution in households where children are present.



### **Avoid a humid or dusty place.**

Placing the projector in a highly humid, dusty place, oily soot or corrosive gas could result in fire or electrical shock.

- \* Do not place near the kitchen, a humidifier or other place where there is oily smoke or humidity.



### **Avoid a high temperature environment.**

The heat could have adverse influence on the cabinet of the projector and other parts. Do not place the projector, the remote control transmitter and other parts in direct sunlight or near a hot object such as heater, etc.



### **Remove the power cord for complete separation.**

- \* For safety purposes, disconnect the power cord if the projector is not to be used for prolonged periods of time.
- \* Before cleaning, turn off and unplug the projector. Neglect could result in fire or electrical shock.



Disconnect the plug from the power outlet.

### **Ask your dealer to cleaning inside of the projector about every two years.**

Accumulations of dust inside the projector cause result in fire or malfunction. Cleaning inside is more effective if performed before every humid periods such as rainy season.



- \* Do not clean inside yourself because it is dangerous.

# *SAFETY PRECAUTIONS (continued)*

---

## **NOTE**

### **Do not give the remote control transmitter any physical impact.**

A physical impact could cause damage or malfunction of the remote control transmitter.

- \* Take care not to drop the remote control transmitter.
- \* Do not place the projector or heavy objects on the remote control transmitter.

### **Take care of the lens.**

- \* Close the slide lens door to prevent the lens surface being scratched when the projector is not used.
- \* Do not touch the lens to prevent fog or dirt of the lens that cause deterioration of display quality.
- \* Use commercially available lens tissue to clean the lens (used to clean cameras, eyeglasses, etc.). Be careful not to scratch the lens with hard objects.

### **Take care of the air filter to normal ventilate.**

When the air filter becomes clogged with dust, etc., the projector may display the message such as “CHECK THE AIR FLOW” or turn off the projector, to prevent the internal heat level rising.

- \* Do not turn on the projector without air filter.
- \* If the air filter is damaged or lost, order the air filter specified in the user’s manual to your dealer.

### **Take care of the cabinet and the remote control transmitter.**

Incorrect care could have adverse influence such as discoloration, peeling paint, etc.

- \* Use a soft cloth to clean the cabinet and control panel of the projector and the remote control transmitter. When excessively soiled dilute a neutral detergent in water, wet and wring out the soft cloth and afterward wipe with a dry soft cloth. Do not use undiluted detergent directly.
- \* Do not use an aerosol sprays, solvents, volatile substances or abrasive cleaner.
- \* Before using chemical wipes, be sure to read and observe the instructions.
- \* Do not allow long-term close contact with rubber or vinyl.

# USER'S MANUAL Vol.1 (Basic)

Thank you for purchasing this projector.



**WARNING** • Please read the accompanying manual “SAFETY INSTRUCTIONS” and this “USER'S MANUAL” thoroughly to ensure correct usage through understanding. After reading, store this instruction manual in a safe place for future reference.

**NOTE** • The information in this manual is subject to change without notice.

- The manufacturer assumes no responsibility for any errors that may appear in this manual
- The reproduction, transmission or use of this document or contents is not permitted without express written authority.

## TRADEMARK ACKNOWLEDGEMENT :

- PS/2, VGA and XGA are registered trademarks of the International Business Machines Corporation.
- Apple, Mac and ADB are registered trademarks of Apple Computer, Inc.
- VESA and SVGA are trademarks of the Video Electronics Standard Association.
- Windows is a registered trademark of Microsoft Corporation.
- All other trademarks are the property of their respective owners.

## CONTENTS

	Page		Page
PROJECTOR FEATURES .....	2	USING THE MAGNIFY	
PREPARATIONS .....	2	FEATURE .....	22
PART NAMES .....	4	FREEZING THE SCREEN .....	22
SETTING UP		ADJUSTING SCREEN WITH	
THE PROJECTOR .....	6	ONE-TOUCH .....	23
CONNECTING		SELECTING THE ASPECT	
YOUR DEVICES.....	8	RATIO.....	24
USING THE REMOTE		TEMPORARILY BLANKING	
CONTROL .....	13	THE SCREEN.....	24
TURNING ON THE POWER .....	15	DISPLAYING CHILD WINDOW	
TURNING OFF THE POWER .....	17	(P. IN. P: Picture in Picture) .....	24
ADJUSTING THE VOLUME .....	18	USING THE MENU	
TEMPORARILY MUTING		FUNCTIONS.....	25
THE SOUND.....	18	OPERATING THE PC SCREEN .....	26
ADJUSTING THE POSITION.....	19	THE LAMP .....	27
USING THE AUTOMATIC		THE AIR FILTER.....	29
ADJUSTMENT FEATURE .....	20	OTHER CARE .....	31
CORRECTING KEYSTONE			
DISTORTIONS .....	21		

## PROJECTOR FEATURES

This liquid crystal projector is used to project various computer signals as well as NTSC / PAL / SECAM video signals onto a screen. Little space is required for installation and large images can easily be realized.

### ● Ultra High Brightness

Crisp, ultra-bright presentations is achieved by using a UHB (ultra high brightness) lamp and a highly efficient optical system

### ● Partial Magnification Function

Interesting parts of images can be magnified for closer viewing

### ● One Touch Function

Just press the ONE TOUCH button to automatically retrieve input signals, calibrate images, and correct keystone distortion

### ● Whisper Mode Equipped

Special mode is available for reducing projector noise to achieve quieter operation

## PREPARATIONS

Your projector should come with the items shown below. Check to make sure that all the items are included. Contact your dealer if anything is missing.

**NOTE** • Keep the original packing material for future reshipment.

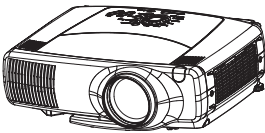

**Projector**  
(with Lens Cap)



**Power cord**  
(US Type)



**Power cord**  
(UK Type)

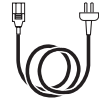

**Power cord**  
(Europe Type)



**User's Manuals**  
(Vol.1/Vol.2)  
**Safety Instructions**

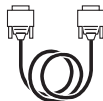

**RGB cable**

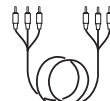

**Video/Audio cable**



**USB mouse cable**

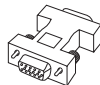

**RS-232C adapter**

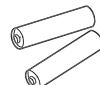

**Two AA batteries**  
(for the remote control)



**Soft carrying case**



**Remote control**

**⚠ WARNING** Precautions to observe in regards to the power cord: Please use extra caution when connecting the projector's power cord as incorrect or faulty connections may result in FIRE AND/OR ELECTRICAL SHOCK. Please adhere to the following safety guidelines to insure safe operation of the projector:

- Only plug the power cord into outlets rated for use with the power cord's specified voltage range.
- Only use the power cord that came with the projector.
- NEVER ATTEMPT TO DEFEAT THE GROUND CONNECTION OF THE THREE-PRONGED PLUG!
- Make sure that you firmly connect the power cord to the projector and wall outlet.

## 1 Connect your devices to the projector

8 ~ 12

Connect your computer, VCR and/or other devices you will be using to the projector.

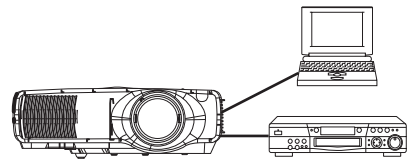

## 2 Insert the batteries into the remote control

13

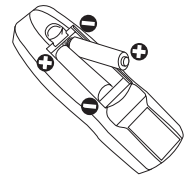

## 3 Connect the power cord

- (1) Connect the connector of the electrical power cord to the AC inlet of the main unit.
- (2) Firmly plug the power cord's plug into the outlet

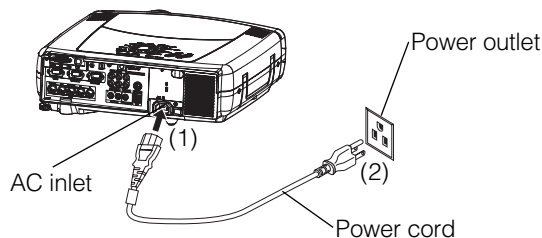

# PART NAMES

## THE PROJECTOR

 Indicates the corresponding reference page

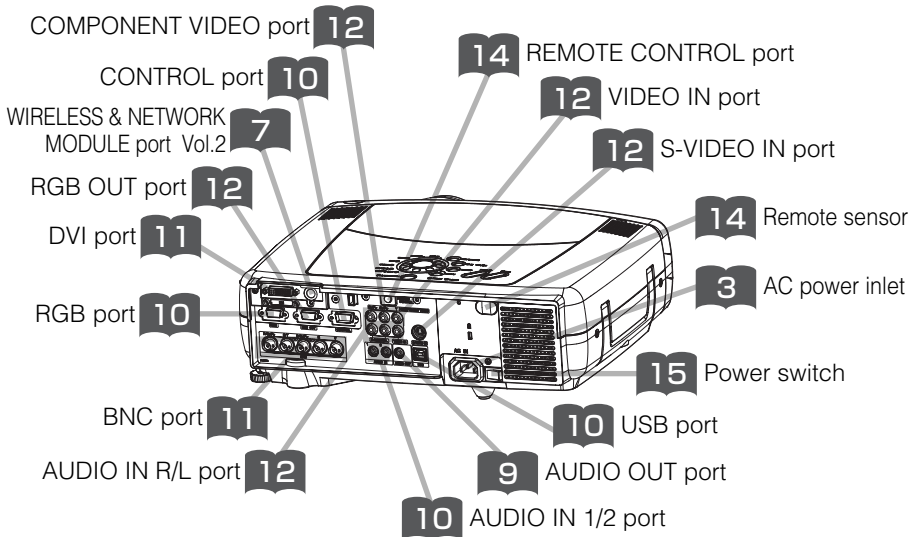
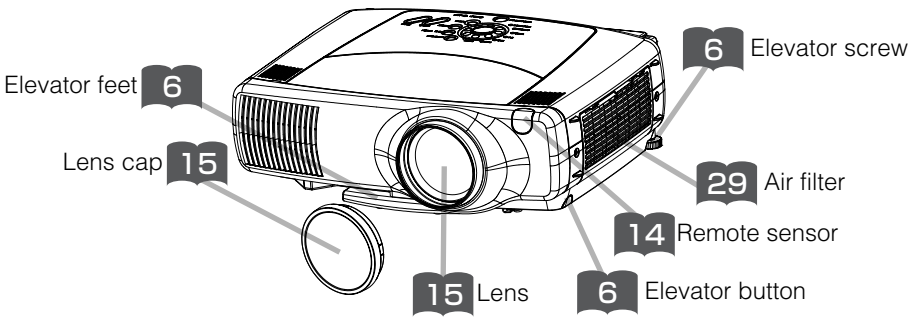
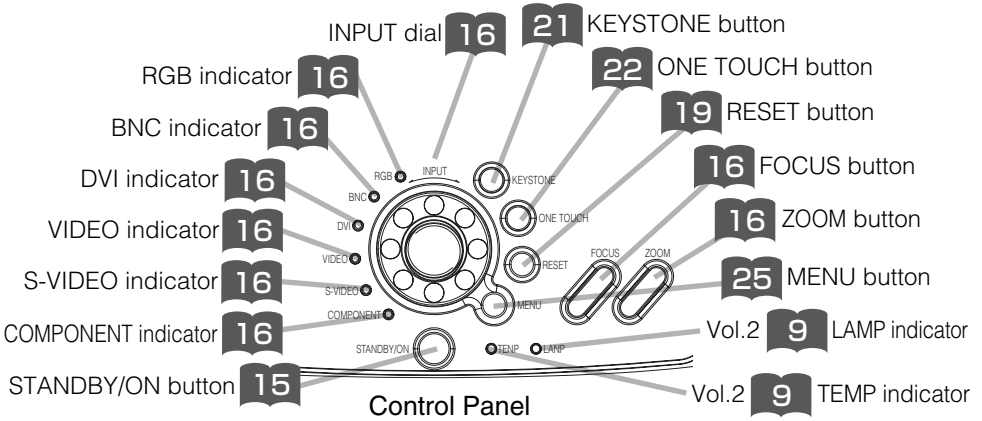



# THE REMOTE CONTROL

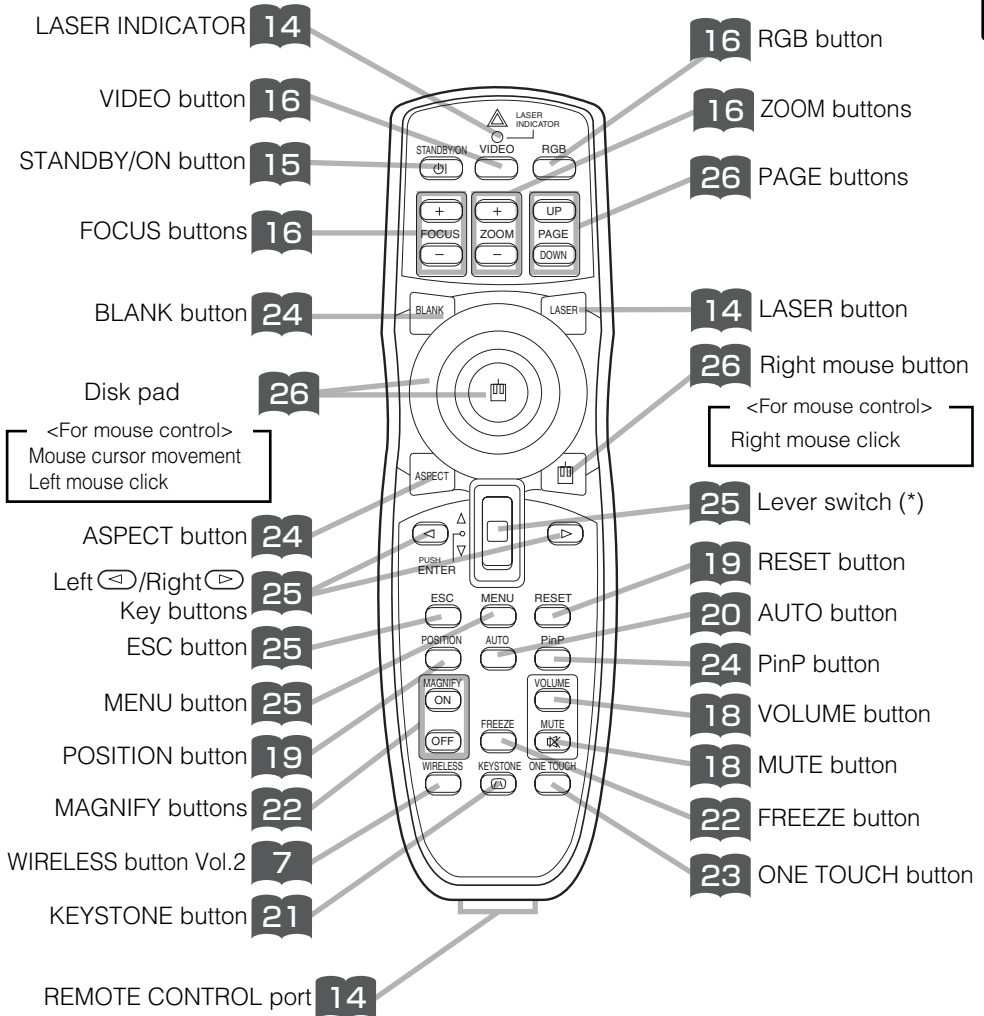

## \* Using the lever switch

- Flip toward disk pad : Up (▲) key
- Flip toward MENU button: Down (▼) key
- Press in center : ENTER button

# SETTING UP THE PROJECTOR

- CAUTION** • Install the projector in a suitable environment according to instructions of the accompanying manual “SAFETY INSTRUCTIONS” and this manual.
- If you press the elevator buttons without holding the projector, the projector might crash down, overturn, smash your fingers and possibly result in malfunction. To prevent damaging the projector and injuring yourself, ALWAYS HOLD THE PROJECTOR whenever using the elevator buttons to adjust the elevator feet.

## Adjusting the Projector's Elevator Feet

If the surface on which the projector is placed, or the screen is tilted, use the elevator feet and elevator screw to adjust the projection angle of the main unit. The adjustment range of the elevator feet is 0 to 9 degrees.

### 1 Press and hold in the elevator buttons

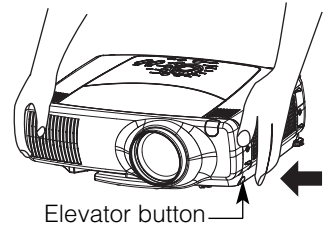

### 2 Raise or lower the projector to the desired height and then release the elevator buttons

When you release the elevator buttons, the elevator feet will lock into position.

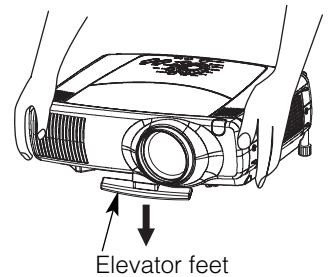

### 3 Turn the elevator screw to fine tune.

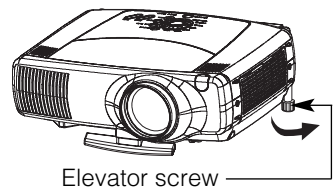

# Adjusting the Screen Size and Projection Distance

Refer to the illustrations and tables below to determine the screen size and projection distance.

The values shown in the table are calculated for a full size screen

- a: Distance from the projector to the screen ( $\pm 10\%$ )
- b: Distance from the lens center to the bottom of the screen ( $\pm 10\%$ )
- c: Distance from the lens center to the top of the screen ( $\pm 10\%$ )

The screen

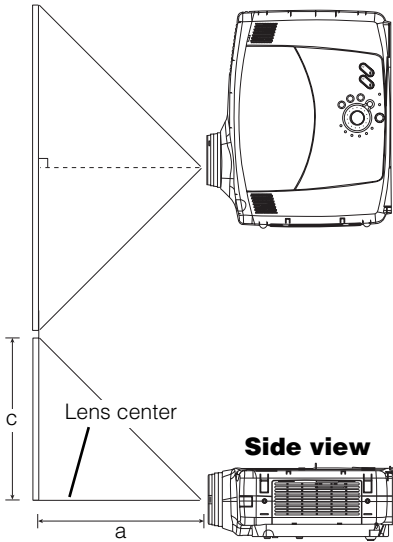

If 4:3 aspect ratio

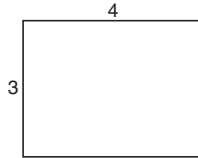

Screen Size [inch (m)]	a [inch (m)]		b [inch (cm)]	c [inch (cm)]
	Min.	Max.		
30 (0.8)	34 (0.9)	52 (1.3)	0 (0)	18 (46)
40 (1.0)	46 (1.2)	71 (1.8)	0 (0)	24 (61)
50 (1.3)	58 (1.5)	89 (2.3)	0 (0)	30 (76)
60 (1.5)	71 (1.8)	107 (2.7)	0 (0)	36 (91)
70 (1.8)	83 (2.1)	126 (3.2)	0 (0)	42 (107)
80 (2.0)	95 (2.4)	144 (3.7)	0 (0)	48 (122)
90 (2.3)	108 (2.7)	162 (4.1)	0 (0)	54 (137)
100 (2.5)	120 (3.0)	181 (4.6)	0 (0)	60 (152)
120 (3.0)	144 (3.7)	217 (5.5)	0 (0)	72 (183)
150 (3.8)	181 (4.6)	272 (6.9)	0 (0)	90 (229)
200 (5.0)	243 (6.2)	364 (9.2)	0 (0)	120 (305)
250 (6.3)	304 (7.7)	455 (11.6)	0 (0)	150 (381)
300 (7.5)	366 (9.3)	547 (13.9)	0 (0)	180 (457)

The screen

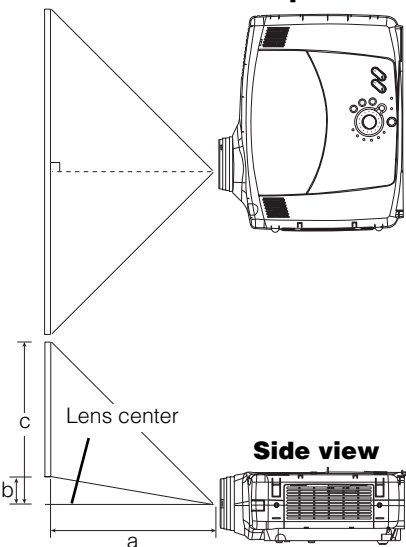

If 16:9 aspect ratio

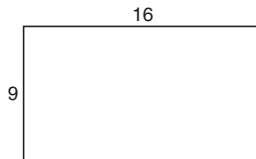

Screen Size [inch (m)]	a [inch (m)]		b [inch (cm)]	c [inch (cm)]
	Min.	Max.		
30 (0.8)	37 (0.9)	57 (1.4)	2 (6.2)	17 (44)
40 (1.0)	50 (1.3)	77 (2.0)	13 (32)	27 (70)
50 (1.3)	64 (1.6)	97 (2.5)	16 (41)	31 (78)
60 (1.5)	77 (2.0)	117 (3.0)	19 (49)	34 (86)
70 (1.8)	90 (2.3)	137 (3.5)	22 (57)	37 (94)
80 (2.0)	104 (2.6)	157 (4.0)	26 (65)	40 (102)
90 (2.3)	117 (3.0)	177 (4.5)	29 (73)	43 (110)
100 (2.5)	131 (3.3)	197 (5.0)	32 (81)	47 (118)
120 (3.0)	157 (4.0)	237 (6.0)	38 (97)	53 (134)
150 (3.8)	198 (5.0)	296 (7.5)	48 (121)	63 (159)
200 (5.0)	265 (6.7)	396 (10.1)	64 (162)	78 (199)
250 (6.3)	332 (8.4)	496 (12.6)	80 (202)	94 (240)
300 (7.5)	399 (10.1)	596 (15.1)	96 (243)	110 (280)

# CONNECTING YOUR DEVICES

## **Devices You Can Connect to the Projector (Refer to this section for planning your device configuration to use for your presentation.)**



**CAUTION** • Incorrect connecting could result in fire or electrical shock. Please read this manual and the separate “SAFETY INSTRUCTIONS”.

### **ATTENTION** Precautions to observe when connecting other devices to the projector

- Whenever attempting to connect other devices to the projector, please thoroughly read the manual of each device to be connected.
- **TURN OFF ALL DEVICES** prior to connecting them to the projector. Attempting to connect a live device to the projector may generate extremely loud noises or other abnormalities that may result in malfunction and/or damage to the device and/or projector. Refer to the “TECHNICAL” of the USER’S MANUAL (Vol.2) for the pin assignment of connectors and RS-232C communication data.
- Make sure that you connect devices to the correct port. Incorrect connection may result in malfunction and/or damage to the device and/or projector.
- Some other cables have to be used with core set. Use the accessory cable or a designated-type cable for the connection. For cables that have a core only at one end, connect the core to the projector.
- Secure the screws on the connectors and tighten.



Indicates the  
corresponding  
reference page

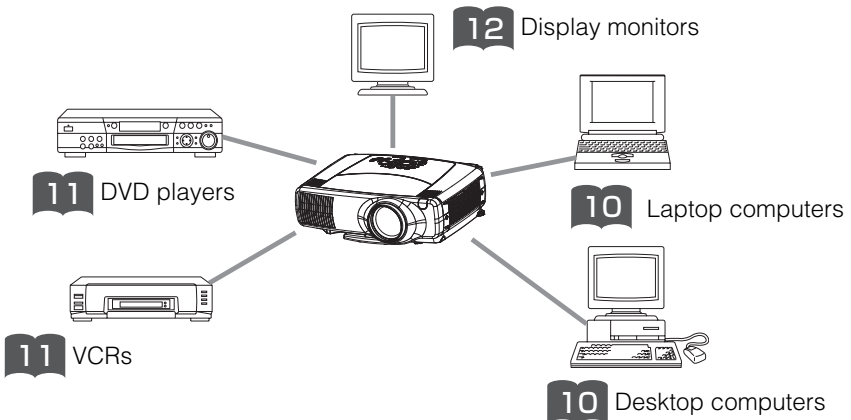

## Ports and Cables

Refer to the table below to find out which projector port and cable to use for connecting a given device. Use this table for determining which cables to prepare.

Function	Projector Port	Connection Cables
Analog RGB input	RGB	RGB cable (With D-sub 15-pin shrink jack and inch thread screws)
	BNC(R/C <sub>R</sub> /P <sub>R</sub> )(G/Y)(B/C <sub>B</sub> /P <sub>B</sub> )(H)(V) • When BNC (RGB) is selected (*)	BNC cable
Analog output	RGB OUT	RGB cable (With D-sub 15-pin shrink jack and inch thread screws)
DVI input	DVI	DVI cable
Audio input from computer	AUDIO IN 1 • Linked to RGB or DVI port input	Audio/video cable (Stereo mini)
	AUDIO IN 2 • Linked to BNC (RGB) port input (*)	
USB mouse control	USB	USB cable
PS/2 mouse control	CONTROL	PS/2 mouse cable
ADB mouse control		ADB mouse cable
Serial mouse control		Serial mouse cable
RS-232C communications		RS-232C adapter + RS-232C cable
S video input	S-VIDEO IN	S-video cable (mini DIN 4-pin jack)
Video input	VIDEO IN	Audio/video cable
Component video input	COMPONENT(C <sub>R</sub> /P <sub>R</sub> )(C <sub>B</sub> /P <sub>B</sub> )(Y)	Component video cable
	BNC(R/C <sub>R</sub> /P <sub>R</sub> )(G/Y)(B/C <sub>B</sub> /P <sub>B</sub> ) • When BNC (COMPONENT) is selected (*)	
Audio input from video equipment	AUDIO IN R,L	Audio/video cable or audio cable (RCA jack)
Audio output	AUDIO OUT	Audio cable (Stereo mini)
Wired remote control signal input	REMOTE CONTROL	Audio cable (Stereo mini)

\* Before using the BNC port, change RGB input to component video input on the BNC menu item of the INPUT menu.

### NOTE About Plug-and-Play Capability

- This projector is compatible with VESA DDC 1/2B. Plug-and-Play can be achieved by connecting this projector to computers that are VESA DDC (display data channel) compatible. Please take advantage of this function by connecting the accessory RGB cable to the RGB port (DDC 1/2B compatible). Plug-and-Play may not work properly if any other type of connection is attempted.
- Plug-and-Play is a system composed of the computer, its operating system and peripheral equipment (i.e. display devices).
- Please use the standard drivers as this projector is a Plug-and-Play monitor.

# CONNECTING YOUR DEVICES (continued)

## Connecting to a Computer

**ATTENTION** Whenever attempting to connect a laptop computer to the projector, be sure to activate the laptop's RGB external image output (set the laptop to CRT display or to simultaneous LCD and CRT display). For details on how this is done, please refer to the instruction manual of the corresponding laptop computer.

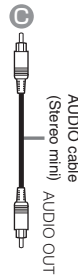
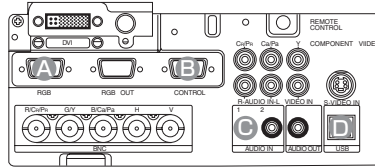
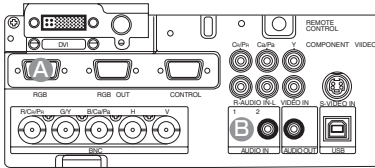

USB cable  
If connecting to a USB port equipped computer



**Laptop computer**



**Desktop computer**

### NOTE

- Some computers may have multiple display screen modes. Use of some of these modes will not be possible with this projector.
- For some RGB input modes, the optional Mac adapter is necessary.

# Connecting to a Computer (continued)

## BNC Input

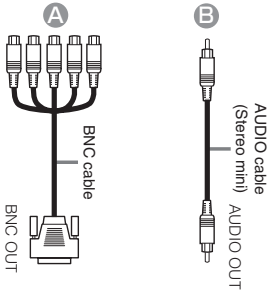
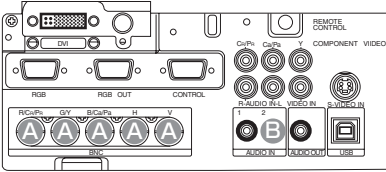

**Desktop computer**

## DVI Input

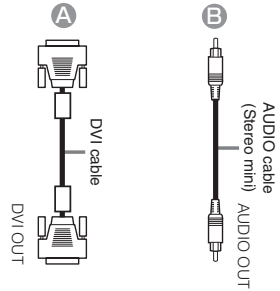
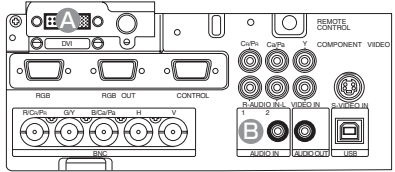

**Desktop computer**

# CONNECTING YOUR DEVICES (continued)

## Connecting to a DVD Player

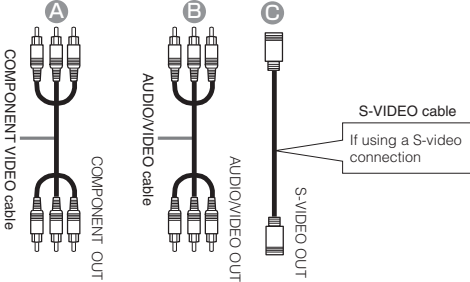
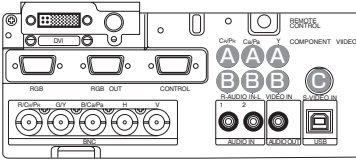

## Connecting to a VCR

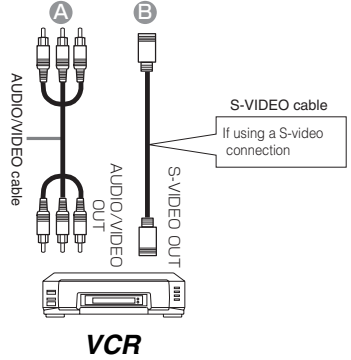
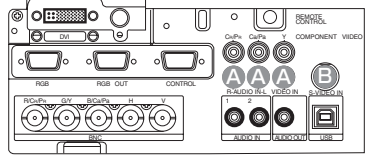

## Connecting to a Display Monitor

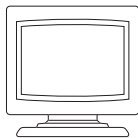
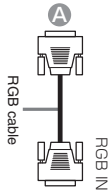
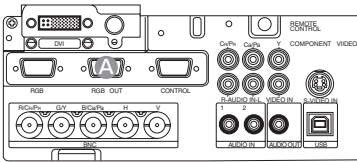



# USING THE REMOTE CONTROL

## Putting batteries into the remote control unit



### **CAUTION** Precautions to observe in regards to the batteries

Always handle the batteries with care and use them only as directed. Improper use may result in battery cracking or leakage, which could result in fire, injury and/or pollution of the surrounding environment.

- Keep the battery away from children and pets.
- Be sure to use only the batteries specified for use with the remote control. Do not mix new batteries with used ones.
- When inserting batteries, verify that the plus and minus terminals are aligned correctly (as indicated in the remote control).
- When you dispose the battery, you should obey the law in the relative area or country.

### **1 Remove the battery cover**

Slide back and remove the battery cover in the direction of the arrow.

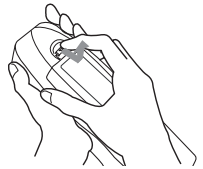

### **2 Insert the batteries**

Align and insert the two AA batteries (that came with the projector) according to their plus and minus terminals (as indicated in the remote control).

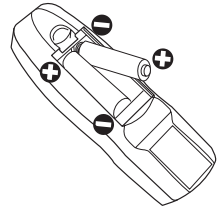

### **3 Close the battery cover**

Replace the battery cover in the direction of the arrow and snap it back into place.



# USING THE REMOTE CONTROL (continued)

## Operating the remote control

- WARNING** • The laser pointer of the remote control transmitter is used in place of a finger or rod. Never look directly into the laser beam outlet or point the laser beam at other people. The laser beam can cause vision problems.
- CAUTION** • Use of controls or adjustments or performance of procedures other than those specified herein may result in hazardous radiation exposure.

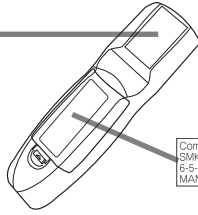

Complies with 21 CFR 1040.10 and 1040.11.  
SHUK CORPORATION  
6-5-5 Togoshi Shinagawa-ku, Tokyo, JAPAN 142-8511  
MANUFACTURED June 2002 PLACE OF MANUFACTURER : A

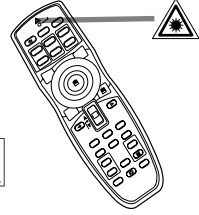

- The remote control works with both the projector's front and rear remote sensors.
- The range of the remote sensor on the front is 3 meters with a 60-degree range (30 degrees to the left and right of the remote sensor), and back is 3 meters with a 40-degree range.
- Since the remote control uses infrared light to send signals to the projector (Class 1 LED), be sure to use the remote control in an area free from obstacles that could block the remote control's output signal to the projector.
- The wired remote control:

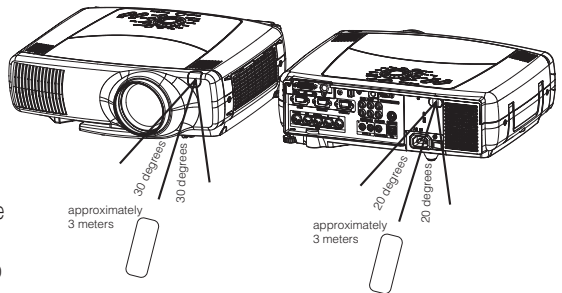

You can use the remote control as a wired remote control, by connecting the REMOTE CONTROL ports of the main unit and remote control via an audio cable (3.5 dia. stereo mini cable with plugs).

### ATTENTION Precautions to observe when using the remote control

- Do not disassemble the remote control.
- Do not drop or otherwise expose the remote control to physical impact.
- Do not get the remote control wet or place it on wet objects. Doing so may result in malfunction.
- Do not place the remote control near the projector's lens, fan, or vents.
- Remove the batteries from the remote control and store them in a safe place if you won't be using the remote control for an extended period.
- Replace the batteries whenever the remote control starts to malfunction.
- When strong light, such as direct sunlight or light from an extremely close range (such as from an inverter fluorescent lamp), hits the projector's remote sensor, the remote control may cease to function. Adjust the direction of the projector to keep light from directly hitting the projector's remote sensor.

# TURNING ON THE POWER

## Precautions

Connect all devices to be used to the projector prior to turning on the power.



**WARNING** When the power is ON, a strong light is emitted. Do not look into the lens.

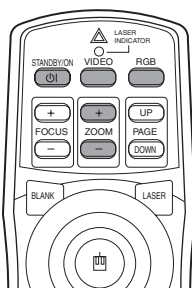

Control panel

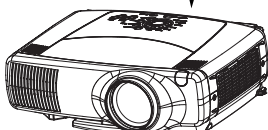
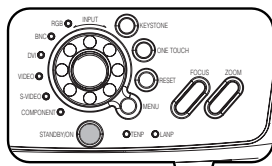

**NOTE** Turn the power on/off in right order.

- Power on the projector before the computer or video tape recorder.
- Power off the projector after the computer or video tape recorder.

- 1 Make sure that the power cord is firmly and correctly connected to the projector and outlet**

3

- 2 Turn on the projector's power**

Set the power switch to [ I ] (ON). The STANDBY/ON indicator will light to solid orange.

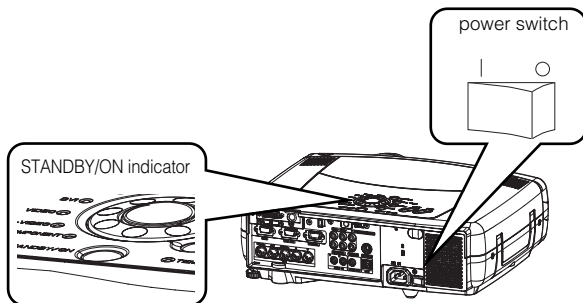

- 3 Press the STANDBY/ON button (control panel or remote control)**

- The projector begins warming up and the STANDBY/ON indicator blinks green.
- The STANDBY/ON indicator stops blinking and lights to solid green once the projector's power is completely on.



- 4 Remove the lens cap**

The picture is projected.

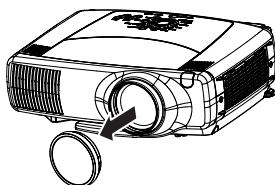

# TURNING ON THE POWER (continued)

## Selecting an Input Signal

### 5 Using the remote control

#### If selecting RGB input Press the RGB button

Press this button to toggle between the devices connected to RGB IN 1 and 2. As illustrated below, each time you press the RGB button, the projector switches between RGB IN 1 and 2. Select the signal you wish to project.

- When BNC (RGB) is selected:

RGB → BNC(RGB) → DVI



- When BNC (COMPONENT) is selected:

RGB ↔ DVI

#### If selecting video input Press the VIDEO button

Press this button to toggle between the devices connected to VIDEO IN, S-VIDEO IN and COMPONENT VIDEO. As illustrated below, each time you press the VIDEO button, the projector switches between VIDEO IN, S-VIDEO IN and COMPONENT VIDEO. Select the signal you wish to project.

- When BNC (RGB) is selected:

VIDEO IN → S-VIDEO IN → COMPONENT VIDEO



- When BNC (COMPONENT) is selected:

VIDEO IN → S-VIDEO IN → COMPONENT VIDEO



### Using the projector's control panel

#### Turn the INPUT dial

Turning the dial cycles through the inputs as shown below. Select the terminal to which the signal you want to project is input.

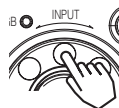

- When BNC (RGB) is selected:

RGB ↔ BNC(RGB) ↔ DVI

↑ ↓  
COMPONENT VIDEO ↔ S-VIDEO ↔ VIDEO

- When BNC (COMPONENT) is selected:

RGB ↔ BNC(COMPONENT) ↔ DVI

↑ ↓  
COMPONENT VIDEO ↔ S-VIDEO ↔ VIDEO

#### NOTE

Turn the INPUT dial and set it at the click point, otherwise input signal selection may be incorrect.

### 6 Use the ZOOM (+) / (-) buttons to adjust the screen size



(Control panel)



(Remote control)

### 7 Use the FOCUS (+) / (-) buttons to adjust the focus



(Control panel)



(Remote control)

# TURNING OFF THE POWER

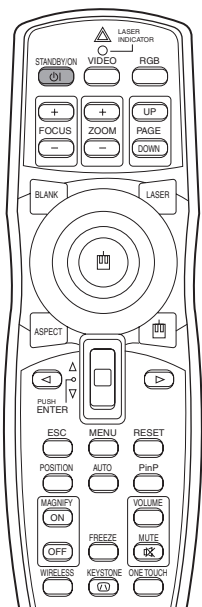

**Control panel**

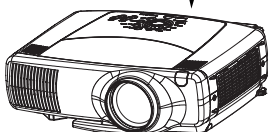
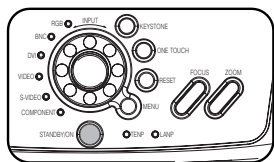

## NOTE

- Except in cases of emergency, do not turn off the power switch while the STANDBY/ON indicator is solid or flashing green. Doing so could shorten the lamp lifetime.

## 1 Press the **STANDBY/ON** button (control panel or remote control)

The message "Power off?" will appear on the screen for approximately 5 seconds.



## 2 Press the **STANDBY/ON** button again (control panel or remote control)

Press the STANDBY/ON button again while the "Power off?" message is visible. The projector lamp goes off and starts cooling down. While cooling, the STANDBY/ON indicator flashes orange. When in this state, pressing the STANDBY/ON button has no effect.

When lamp cooling is complete, the STANDBY/ON indicator stops flashing, and turning solid orange.



## 3 Check that the **STANDBY/ON** indicator stops blinking and lights to solid orange. Switch the power switch to [O] (OFF).

STANDBY/ON indicator

power switch

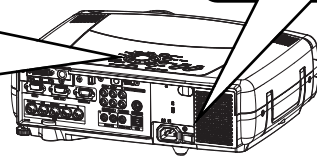
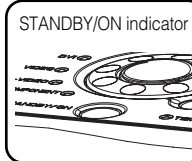

## 4 Confirm that the **STANDBY/ON** indicator has gone off and then attach the lens cap.

When the projector has completed powering down, the STANDBY/ON indicator will go off.

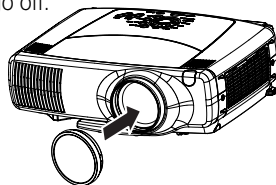

# ADJUSTING THE VOLUME

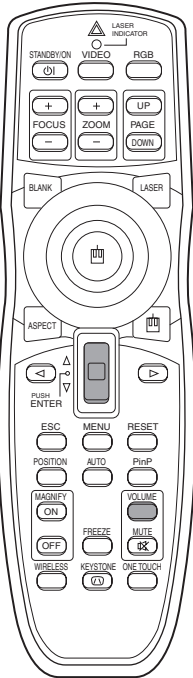

## 1 Press the **VOLUME** button

As illustrated on the right, a dialog will appear on the screen to aid you in adjusting the volume.

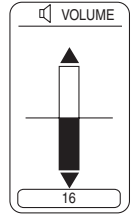

## 2 Use the lever switch / to adjust the volume

Press the VOLUME button again to close the dialog and complete this operation. (Even if you don't do anything, the dialog will automatically disappear after a few seconds.)

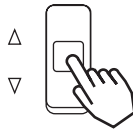

 Press this to increase the volume

 Press this to decrease the volume

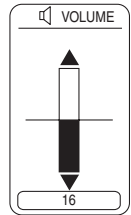

# TEMPORARILY MUTING THE SOUND

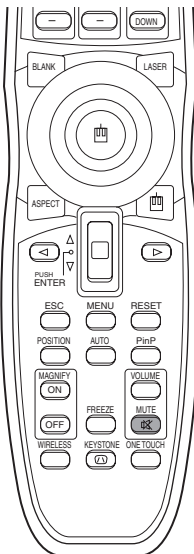

## 1 Press the **MUTE** button

As illustrated on the right, a dialog will appear on the screen indicating that you have muted the sound. Press the VOLUME button to close the dialog. (Even if you don't do anything, the dialog will automatically disappear after a few seconds.)

Press the MUTE button again to restore the sound.

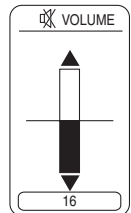

# ADJUSTING THE POSITION

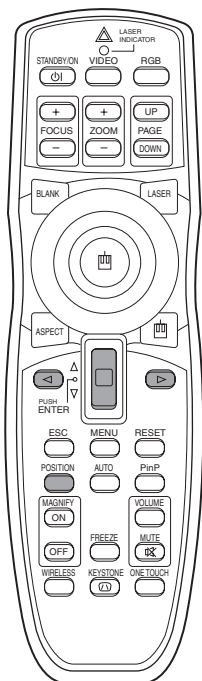

## 1 Press the **POSITION** button

As illustrated on the right, a dialog will appear on the screen to aid you in adjusting the position.



## 2 Use the **<**, **>**, **▲**, **▼** buttons to adjust the position

When you want to initialize the position, press the **RESET** button during adjustment.

Press the **POSITION** button again to close the dialog and complete this operation. (Even if you don't do anything, the dialog will automatically disappear after a few seconds.)

This function is only available for RGB/BNC (RGB) input.

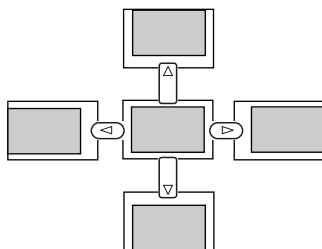
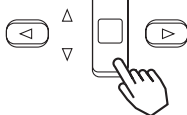

# USING THE AUTOMATIC ADJUSTMENT FEATURE

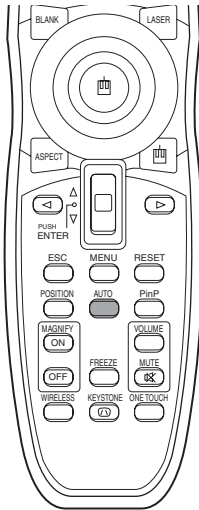

1

## Press the **AUTO** button



### **Automatic Adjustment for RGB Input**

Horizontal position (H. POSIT), vertical position (V. POSIT), clock phase (H. PHASE) and horizontal size (H. SIZE) are automatically adjusted.

Make sure that the application window is set to its maximum size prior to attempting to use this feature. Dark pictures may still be incorrectly adjusted. Use a bright screen when adjusting.

### **Automatic Adjustment for Video Input**

The signal type best suited for the respective input signal is selected automatically.

This feature is available only if VIDEO is set to AUTO in the INPUT menu.

#### **NOTE**

The automatic adjustment operation requires approximately 10 seconds. Also, please note that it may not function correctly with some input signals.



# CORRECTING KEYSTONE DISTORTIONS

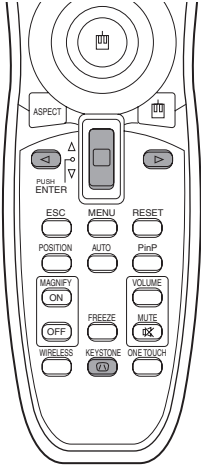

## 1 Press the **KEYSTONE** button

As illustrated on the right, a dialog will appear on the screen to aid you in correcting the distortion.

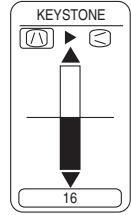

## 2 Use the **<**, **>** buttons to select the direction of distortion to correct (**⏏**/**⏏**)

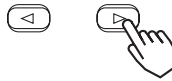

## 3 Use the lever switch **⏏** / **⏏** to correct distortion

Press the KEystone button again to close the dialog and complete this operation. (Even if you don't do anything, the dialog will automatically disappear after a few seconds.)

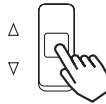

### NOTE

- This function may not work well with some types of input signals.
- The adjustable range for correcting keystone distortions will vary with the type of input signal.

# USING THE MAGNIFY FEATURE

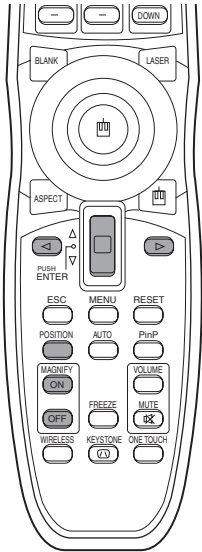





## 1 Press the **MAGNIFY (ON)** button

The projector enters MAGNIFY mode.



## 2

Press the **POSITION** button, then use the lever switch  / ,  /  to select the area to zoom. Press the **POSITION** button again to finalize the zoom area.

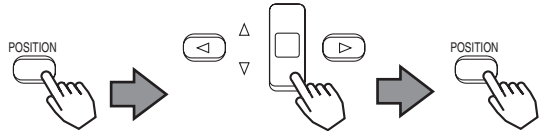

## 3

Use the lever switch  /  to adjust the zoom level

Press the MAGNIFY (OFF) button to exit MAGNIFY mode and restore the screen to normal. (The projector will also automatically exit MAGNIFY mode if there is a change in the input signal's state.)

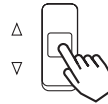

### NOTE

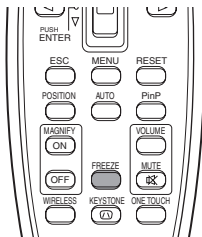

The projector will automatically exit from MAGNIFY mode if either the INPUT SELECT, AUTO, ASPECT or VIDEO feature is used, or, if there is a change in the input signal's state.

# FREEZING THE SCREEN



## 1

Press the **FREEZE** button

The  icon appears and the screen will freeze at the current image. Press the FREEZE button again and the  appears as the projector exits FREEZE mode.



### NOTE

- The projector will automatically exit from FREEZE mode if either the POSITION, VOLUME, MUTE, AUTO, BLANK ON/OFF or MENU ON/OFF feature is used, or, if there is a change in the input signal's state.
- If the projector continues projecting the same image for a long time (i.e. you forget to exit FREEZE mode), the image might possibly remain as an afterimage. Do not leave the projector in FREEZE mode for too long.

# ADJUSTING SCREEN WITH ONE-TOUCH

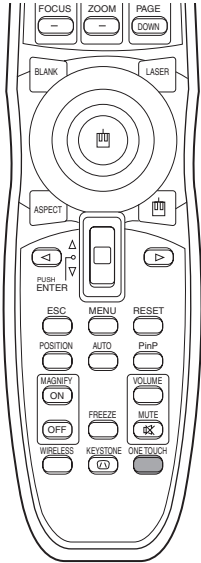

1

## Press the ONE TOUCH button

You can activate the following functions just by pressing the ONE TOUCH button:



(1) **Signal search:** Cycle through input signals, displaying the images of retrieved signals. If no signal is found, returns to the signal that was selected before the search was begun.

- When BNC (RGB) is selected:

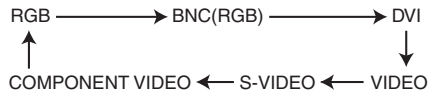

- When BNC (COMPONENT) is selected:

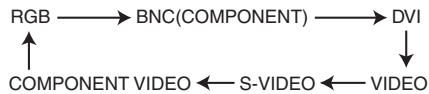

(2) **Automatic adjustment:** In RGB mode, automatically adjust the picture position and size; for VIDEO input, automatically select the signal mode. ( 20 )

(3) **Automatic keystone distortion correction:** This is only performed if ONE TOUCH of the AUTO menu is set to TURN ON. When performed, the unit automatically corrects vertical keystone distortion due to the (forward/backward) setup angle of the main unit. (Vol.2 5 )

## NOTES

- May not function properly with some input signals.
- This function takes about 10 seconds to display an image.

## SELECTING THE ASPECT RATIO

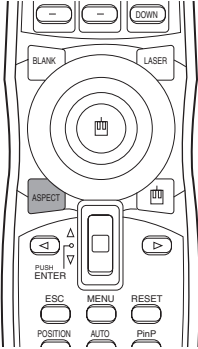

### 1 Press the **ASPECT** button

RGB, DVI, COMPONENT VIDEO

(HDTV signals : 1125i (1035i/1080i), 750p)

4:3 ↔ 16:9

VIDEO IN, S-VIDEO IN, COMPONENT VIDEO

(Non-HDTV signals : 525i, 525p, 625i)

4:3 → 16:9 → SMALL



## TEMPORARILY BLANKING THE SCREEN

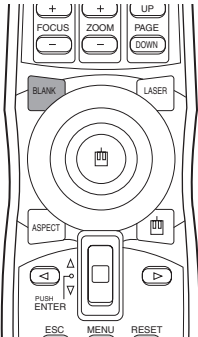

### 1 Press the **BLANK** button

The input signal screen is shut off, and a blank screen appears. You can set the blank screen using the menu (from the SCREEN menu, select BLANK). Press the BLANK button again to remove the blank screen, and return to the input signal screen.



## DISPLAYING CHILD WINDOW (P. IN. P: Picture in Picture)

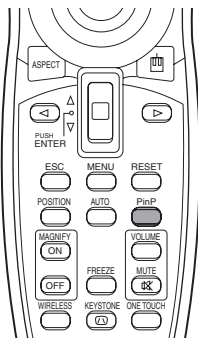

### 1 Press the **P. in P. Button**

You can display the video input in a child window while displaying RGB, BNC, or DVI input.



Display child window (small) → Display child window (large) → No display

You can select the video input to display in the child window, and the position of the child window, from the INPUT menu. (Vol.2 4)

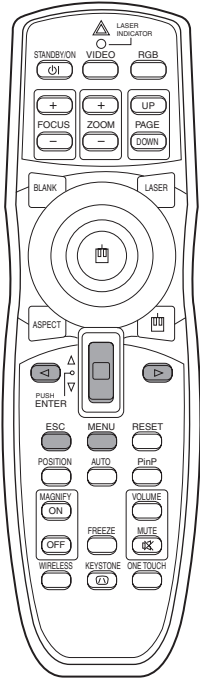
# USING THE MENU FUNCTIONS



## 1 Press the MENU button



The menu display appears on the screen. The projector has the following menus: MAIN, PICTURE-1, PICTURE-2, INPUT, AUTO, SCREEN, and OPTION, WIRELESS. When you select a menu name using the lever switch  / , the current settings of items that can be manipulated from that menu are displayed.



## 2 Use the lever switch / to select a menu, then press the or ENTER button

The display of the selected menu appears.

[ex. Adjusting SHARPNESS]

Use the lever switch  /  to select PICTURE-1, then press the  or ENTER button.

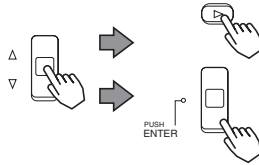



MENU	
MAIN	COLOR BAL R -1
	COLOR BAL B +1
PICTURE-1	SHARPNESS -1
PICTURE-2	COLOR +1
INPUT	TINT -1
AUTO	
SCREEN	
OPTION	
WIRELESS	
SELECT	

## 3 Use the lever switch / to select SHARPNESS, then press the or ENTER button

The operation display of the selected item appears. To adjust a numerical value, press the  or ENTER button again to switch to the single menu (small display showing only the operation display area).

[ex. Adjusting SHARPNESS]

Use the lever switch  /  to select SHARPNESS, then press the  or ENTER button.

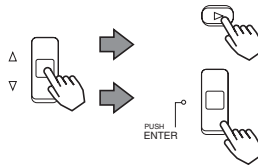

MENU	
MAIN	COLOR BAL R
	COLOR BAL B
PICTURE-1	SHARPNESS
PICTURE-2	COLOR
INPUT	TINT
AUTO	
SCREEN	
OPTION	
WIRELESS	
SELECT	

### NOTE

- For details about menu operations, see the separate "MULTI FUNCTIONAL SETTINGS" (Vol. 2).

## 4 Use the lever switch / to adjust the level

Press the MENU button to hide the menu and finish your operation. Alternatively, press the  or ESC button to return to the previous display.

[ex. Adjusting SHARPNESS]

Use the lever switch  /  to adjust the sharpness.



# OPERATING THE PC SCREEN

You can use the remote control as a simplified mouse or keyboard.

**CAUTION** Caution: Mistaken use of the mouse/keyboard control could damage your equipment.

- Only connect to a PC.
- Before connecting, read the manuals of the device you will connect.
- Do not unplug the connector cables while the computer is operating.

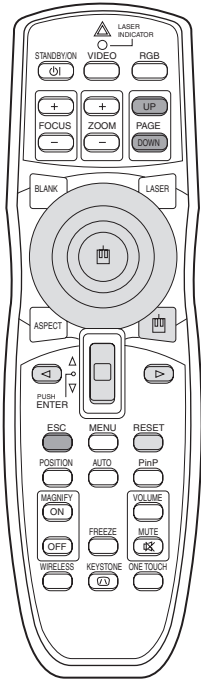

## PS/2, ADB, Serial Mouse Control

1. Turn off the projector and PC power, and connect the projector's CONTROL terminal to the computer via the mouse cable.
2. If a USB cable is connected, disconnect it. If a USB cable is connected, the USB control function is given priority, and mouse control from the CONTROL terminal will not function.
3. Turn on the projector power, then the computer.

The functions in the table below can be controlled. If you have difficulty with control, restart the computer (either from the software or by pressing the restart button).

Available Functions	Remote Control Operation
Move Pointer	Move using  on the disk pad
Left click with mouse	Press the center  of the disk pad
Right click with mouse	Press the right mouse button

## USB Mouse/Keyboard Control

1. Connect the projector's USB terminal to a PC using a USB cable. The functions in the table below can be controlled.

Available Functions	Remote Control Operation
Move Pointer	Move using  on the disk pad
Left click with mouse	Press the center  of the disk pad
Right click with mouse	Press the right mouse button
Press the keyboard's     keys	Press
Press the keyboard's ENTER key	Press the ENTER button
Press keyboard's PAGE UP key	Press PAGE UP button
Press keyboard's PAGE DOWN key	Press PAGE DOWN button
Press keyboard's ESC key	Press ESC button

### NOTES

- It may not be possible to control notebook PCs, and other computers with built-in pointing devices (e.g. track balls), using this remote control. In this case, before connecting go into BIOS (system setup) and select external mouse, and disable the pointing devices. In addition, the mouse may not function if the computer does not have the needed utility program. See your computer's hardware manual for details.
- The USB control can be used with Windows 95 OSR 2.1 or higher. It may not be possible to use the remote control, depending on the computer's configurations and mouse drivers.
- The USB control can only be used for the functions listed above. You cannot do things like press two buttons at once (for instance, pressing two buttons at the same time to move the mouse pointer diagonally).
- This function is not available while the lamp is warming up (the POWER indicator flashes green), while adjusting the volume and display, correcting for trapezoidal distortion, zooming in on the screen, using the BLANK function, or displaying the menu screen.

# THE LAMP



**HIGH VOLTAGE  
HIGH TEMPERATURE  
HIGH PRESSURE**

To replace the lamp, check the model number of the replacement lamp (sold separately) and contact your local dealer.

Replacement lamp model number: DT00531

If the projector is mounted on the ceiling, or if the lamp has broken, ask your dealer to replace the lamp. Lamp replacement is hazardous and should not be attempted by the user.

Before replacing the lamp, make sure the power switch is off and the power cable is not plugged in, then wait at least 45 minutes for the lamp to cool sufficiently. Handling the lamp while hot can cause burns, as well as damaging the lamp.

**⚠ WARNING** The LCD projector uses a glass lamp bulb. It is a mercury lamp with high internal pressure. High-pressure mercury lamps can break with a loud bang, or burn out, if jolted or scratched, or through wear over time. Each lamp has a different lifetime, and some may burst or burn out soon after you start using them. In addition, when the bulb bursts, it is possible for shards of glass to fly into the lamp housing, and for gas containing mercury to escape from the projector's vent holes.

- Do not open the lamp cover while the projector is suspended from above. This is dangerous, since if the lamp's bulb has broken, the shards will fall out when the cover is opened. In addition, working in high places is dangerous, so ask your local dealer to have the lamp replaced even if the bulb is not broken.
- Handle with care: jolting or scratching could cause the lamp bulb to burst during use.
- If the replace lamp indicator (see "Related Messages" (Vol.2 **8**) and "Regarding the indicator Lamps" (Vol.2 **9**)) comes on, replace the lamp as soon as possible. Using the lamp for long periods of time, or past the replacement date, could cause it to burst. Do not use old (used) lamps; this is a cause of breakage.
- If the lamp breaks soon after the first time it is used, it is possible that there are electrical problems elsewhere besides the lamp. If this happens, contact your local dealer or a service representative.
- If the lamp should break (it will make a loud bang when it does), ventilate the room well, and make sure not to breathe the gas that comes out of the projector vents, or get it in your eyes or mouth.
- If the lamp should break (it will make a loud bang when it does), unplug the power cord from the outlet, and make sure to request a replacement lamp from your local dealer. Note that shards of glass could damage the projector's internals, or cause injury during handling, so please do not try to clean the projector or replace the lamp yourself.
- Obey local ordinances when disposing of used lamps. In most cases, it is possible to dispose of used bulbs in the same manner as used glass bottles, but in some cases, bulbs are sorted separately.
- Do not use the projector with the lamp cover removed.

# THE LAMP (continued)

## Replacing the lamp

All projector lamps will wear out eventually. If used for long periods of time, the image could become darkened, and the color contrast could be impacted as well. We recommend that you replace your lamps early. If the LAMP indicator turns red, or a message prompts you to replace the lamp when you power up the projector, the lamp needs to be replaced. (See "Related Messages" (Vol.2 [3](#)) and "Regarding the Indicator Lamps" (Vol.2 [9](#)) for details.)

- 1 Turn off the projector, and unplug the power cord. Allow the lamp bulb to cool for at least 45 minutes, and prepare a new lamp (serial number: DT00531)**

- 2 After making sure that the projector has cooled adequately, slide the knob of a lamp cover lock as shown in the figure. Then, one side of the lamp cover is raised. Pull up the lamp cover and remove it, as shown in the figure**

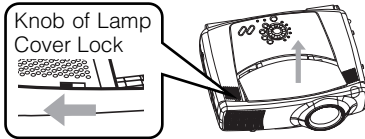

- 3 Unscrew the 3 screws, and slowly pull out the lamp by the handle**

- Be careful not to touch the inside of the lamp case.

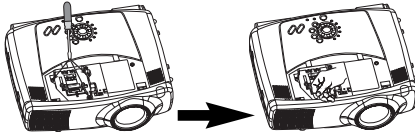

- 4 Insert the new lamp, and tighten the 3 screws firmly to lock it in place**

- 5 Interlocking the 2 tabs of the lamp cover to the projector, put the lamp cover on the projector. Then push the point of the lamp cover to fix it, as shown in the figure. Make sure that the lamp cover doesn't come up**

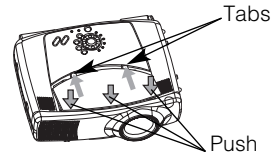

- 6 Turn on the projector power, and reset the lamp timer**

- To reset the lamp timer, from the OPTION menu, select the LAMP TIME. (Vol.2 [7](#))

**ATTENTION** • Make sure that the screws are screwed in firmly. Loose screws could result in damage or injury.



- Do not use with lamp cover removed.
- Do not reset the lamp timer without replacing the lamp. Reset the lamp timer always when replacing the lamp. The message functions will not operate properly if the lamp timer is not reset correctly.
- When the lamp has been replaced after the message of "CHANGE THE LAMP .....THE POWER WILL TURN OFF AFTER 0 hr." is displayed, or the LAMP indicator is red, complete the following operation within 10 minutes of switching power on.

**NOTE** • The LAMP indicator is also red when the lamp unit reaches high temperature. Before replacing the lamp, switch power off, wait approximately 20 minutes, and switch power on again. If the LAMP indicator is still red, replace the lamp.



# THE AIR FILTER

## ***Caring for the air filter***

The air filter should be cleaned about every 100 hours. If the LAMP indicator and TEMP indicator blink red simultaneously, or a message prompts you to clean the air filter when you turn on the unit, the filter needs to be cleaned. (See "Related Messages" (Vol.2 ) and "Regarding the Indicator Lamps" (Vol.2 ) for details.)

### **1 Turn off the projector, and unplug the power cord**

### **2 Apply a vacuum cleaner to the top of the air filter cover to clean the air filter**

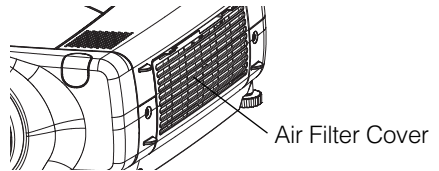

### **3 Turn on the projector, and use the menu to reset the filter timer**

- To reset the air filter timer, from the OPTION menu, select FILTER TIME.

## THE AIR FILTER (continued)

### ***Replacing the air filter***

If the soiling will not come off the air filter, or it becomes damaged, then it needs to be replaced. Please contact your local dealer, after confirming the model of your separately sold replacement air filter.

Replacement air filter model: NJ07081

**1 Turn off the projector, and unplug the power cord. Prepare a new air filter (one specified for your projector)**

**2 Remove the air filter cover and air filter**

**3 Insert the new filter, and replace the filter cover**

**4 Turn on the projector power, and using the menu, reset the filter timer**

- To reset the lamp timer, from the OPTION menu, select FILTER TIME.

**ATTENTION** • Make sure to turn off the power and unplug the power cord before caring for the unit. Please carefully read "Safety Instructions", in order to care for your projector correctly.

- Do not use with air filter cover removed.
- If the air filter becomes clogged by dust or the like, internal temperature rises and could cause malfunction. The power is automatically turned off in order to prevent the unit from overheating internally.

## OTHER CARE

### **Caring for the inside of the projector :**

In order to ensure the safe use of your projector, please have it cleaned and inspected by your local dealer about once every 2 years. Never try to care for the inside of the unit yourself. Doing so is dangerous.

### **Caring for the lens :**

Lightly wipe the lens with a commercially available lens-cleaning wipe. Do not touch the lens directly with your hand.

### **Caring for the cabinet and remote control transmitter :**

Wipe lightly with gauze or a soft cloth. If soiling is severe, dip a soft cloth in water or a neutral cleanser diluted in water, and wipe lightly after wringing well. Then, wipe lightly with a soft, dry cloth.

**ATTENTION** • Make sure to turn off the power and unplug the power cord before caring for the unit. Please carefully read "Safety Instructions" in this manual, in order to care for your projector correctly.

- Do not use cleaners or chemicals other than those listed above, including benzene and paint thinner.
- Do not use aerosols or sprays.
- Do not polish or wipe with hard objects.



# USER'S MANUAL Vol.2 (Extended)

Thank you for purchasing this projector.



**WARNING** • Please read the accompanying manual “SAFETY INSTRUCTIONS” and this “USER'S MANUAL” thoroughly to ensure correct usage through understanding. After reading, store this instruction manual in a safe place for future reference.

**NOTE**

- The information in this manual is subject to change without notice.
- The manufacturer assumes no responsibility for any errors that may appear in this manual
- The reproduction, transmission or use of this document or contents is not permitted without express written authority.

**TRADEMARK ACKNOWLEDGEMENT :**

- PS/2, VGA and XGA are registered trademarks of the International Business Machines Corporation.
- Apple, Mac and ADB are registered trademarks of Apple Computer, Inc.
- VESA and SVGA are trademarks of the Video Electronics Standard Association.
- Windows is a registered trademark of Microsoft Corporation.
- All other trademarks are the property of their respective owners.

## CONTENTS

	Page
<b>MULTIFUNCTIONAL SETTINGS .....</b>	<b>2</b>
<b>WHAT TO DO WHEN YOU THINK A MACHINE DEFECT HAS OCCURRED .....</b>	<b>8</b>
<b>SPECIFICATIONS .....</b>	<b>11</b>
<b>WARRANTY AND AFTER-SERVICE .....</b>	<b>12</b>



For "TECHNICAL" see the end of this manual.

# MULTIFUNCTIONAL SETTINGS



This device has 8 separate menus: **MAIN, PICTURE-1, PICTURE-2, INPUT, AUTO, SCREEN, OPTION, WIRELESS**. Each of these menus is operated using the same methods. The basic operations of these menus are as follows.

**Menu screen display** : Press the "MENU" button.

**Menu selection** : Use the lever switch / to select a menu name, then press the  or ENTER button.

**Item selection** : Use the lever switch / to select an item, then press the  or ENTER button.

**Return menu to last previous screen**: Press the  button or the ESC button.

**Execution of settings and/or adjustments**: Perform the operation using the lever switch /.  
(For further details, read the explanation for each separate menu.)

**Initialization of settings and/or adjustments**: During operation, press the RESET button.  
(Functions that are executed at the same time as a selection, including H PHASE, LANGUAGE selection, and ADJUST, will not be reset.)

**End menu operations**: Press the MENU button, or do not perform any operation for several seconds.

## MAIN Menu





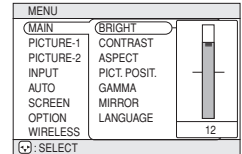







































With the MAIN menu, the seven items shown in the Table below can be performed.

Perform each operation in accordance with the instructions in the Table.



Example : MAIN Menu (BRIGHT)

## MAIN Menu

Item	Description
<b>BRIGHT</b>	<b>Adjust Brightness:</b> Light  ⇔  Dark
<b>CONTRAST</b>	<b>Adjust Contrast:</b> Strong  ⇔  Weak
<b>ASPECT</b>	<b>Select Aspect Ratio:</b> At RGB Input or Hi-Vision 1125i(1035i/1080i)/750p of COMPONENT VIDEO Input: 4:3  ⇔  16:9 At VIDEO Input, S-VIDEO Input or 525i/525p/625i of COMPONENT VIDEO Input: 4:3  ⇔  16:9  ⇔  SMALL • The SMALL picture may not be displayed correctly with certain input signals.
<b>PICT.POSIT.</b>	<b>Select Picture Position (for 16:9/SMALL Picture):</b> TOP  ⇔  CENTER  ⇔  BOTTOM
<b>GAMMA</b>	<b>Select Gamma Mode:</b> NORMAL  ⇔  CINEMA  ⇔  DYNAMIC
<b>MIRROR</b>	<b>Select Mirror Status:</b> NORMAL  ⇔  H:INVERT  ⇔  V:INVERT  ⇔  H&V:INVERT
<b>LANGUAGE</b>	<b>Select Menu Language:</b> ENGLISH  ⇔  FRANÇAIS  ⇔  DEUTSCH  ⇔  ESPAÑOL  ⇔  ITALIANO  ⇔  NORSK  ⇔  NEDERLANDS  ⇔  日本語  ⇔  POTUGUÊS  ⇔  中文  ⇔  한글

## PICTURE-1 Menu

With the PICTURE-1 menu, the five items shown in the Table below can be performed.  
Perform each operation in accordance with the instructions in the Table.

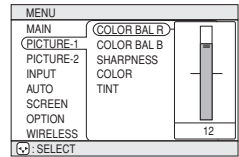

Example : PICTURE1 Menu (COLOR BAL R)

### PICTURE-1 Menu

Item	Description
COLOR BAL R	<b>Adjust Red Color Balance:</b> Dark  ⇌  Light
COLOR BAL B	<b>Adjust Blue Color Balance:</b> Dark  ⇌  Light
SHARPNESS	<b>Adjust Sharpness (for VIDEO/S-VIDEO):</b> Clear  ⇌  Soft
COLOR	<b>Adjust COLOR (for VIDEO/S-VIDEO/COMPONENT VIDEO):</b> Dark  ⇌  Light
TINT	<b>Adjust Tint (for VIDEO/S-VIDEO):</b> Green  ⇌  Red

## PICTURE-2 Menu

With the PICTURE-2 menu, the five items shown in the Table below can be performed.  
Perform each operation in accordance with the instructions in the Table.

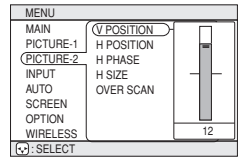

Example : PICTURE2 Menu (V POSITION)

### PICTURE-2 Menu

Item	Description
V POSITION	<b>Adjust Vertical Position (for RGB):</b> Up  ⇌  Down
H POSITION	<b>Adjust Horizontal Position (for RGB):</b> Left  ⇌  Right
H PHASE	<b>Adjust Horizontal Phase (for RGB/COMPONENT VIDEO):</b> Right  ⇌  Left • Adjust to eliminate flicker.
H SIZE	<b>Adjust Horizontal Size (for RGB):</b> Large  ⇌  Small • If the horizontal size adjustment is excessive, the image may not be displayed correctly. In such a case, initialize H SIZE with the RESET button.
OVER SCAN	<b>Select Over-scan Ratio (for VIDEO/S-VIDEO/COMPONENT VIDEO):</b> LARGE  ⇌  MIDDLE  ⇌  SMALL • If you select LARGE, you may note streaking on the top and bottom of the screen, or flicker. If this is irritating, we suggest you select SMALL.

# MULTIFUNCTIONAL SETTINGS (continued)

## INPUT Menu

The three Input menu items listed in the table below can be manipulated. For RGB input, the reception signal's horizontal and vertical frequency is displayed on the initial menu screen. Use the table below as a guide for operation.

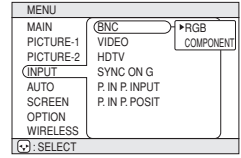

Example : INPUT Menu (BNC)

## INPUT Menu

Item	Description
<b>BNC</b>	<p><b>BNC Pin (R/C<sub>R</sub>/P<sub>R</sub>, G/Y, B/C<sub>B</sub>/P<sub>B</sub>, H, V) function selection:</b>            BNC (RGB)  ⇌  BNC (COMPONENT)</p> <p> (R) (G) (B) (H) (V)   (C<sub>R</sub>/P<sub>R</sub>) (Y) (C<sub>B</sub>/P<sub>B</sub>) (-) (-) </p> <p>(Pins for RGB) (Pins for COMPONENT)</p> <p>Selecting BNC (RGB) allows the 5 RGB2 pins (R/C<sub>R</sub>/P<sub>R</sub>, G/Y, B/C<sub>B</sub>/P<sub>B</sub>, H, V) to be used as RGB signal BNC input as-is.            Selecting BNC (COMPONENT) allows the 3 leftmost RGB2 pins (R/C<sub>R</sub>/P<sub>R</sub>, G/Y, B/C<sub>B</sub>/P<sub>B</sub>) to be used as the COMPONENT VIDEO input C<sub>R</sub>/P<sub>R</sub>, Y, and C<sub>B</sub>/P<sub>B</sub> pins.</p>
<b>VIDEO</b>	<p><b>Select Mode of Signal Type (for VIDEO/S-VIDEO):</b>            AUTO  ⇌  NTSC  ⇌  PAL  ⇌  SECAM  ⇌  NTSC4.43  ⇌  M-PAL  ⇌  N-PAL</p> <p>When AUTO is selected, the video/ S-video input function under ADJUST (  ) are enabled, and is executed simultaneously so that the optimum signal mode is selected from among the modes listed above.            Use this function if the image becomes unstable with VIDEO/S-VIDEO. (e.g. The image becomes irregular, or lacks color.)</p> <ul style="list-style-type: none"> <li>• AUTO mode may not function correctly with a PAL60 signal and certain other signals.</li> <li>• The AUTO mode operation requires approximately 10 seconds.</li> <li>• For COMPONENT VIDEO, the signal type is identified automatically even if this function is inactive. For a HDTV signal, refer to the item HDTV below.</li> </ul>
<b>HDTV</b>	<p><b>Select HDTV Signal Mode:</b> 1080i  ⇌  1035i</p> <ul style="list-style-type: none"> <li>• If the selected HDTV mode is incompatible with the input signal, the picture may be distorted.</li> </ul>
<b>SYNC ON G</b>	<p><b>On/Off SYNC ON G Mode:</b> TURN ON  ⇌  TURN OFF</p> <p>Selecting TURN ON turns on the SYNC ON G mode. The SYNC ON G mode allows reception of SYNC on G.</p> <ul style="list-style-type: none"> <li>• In the SYNC ON G mode, the picture may be distorted with certain input signals. In such a case, remove the signal connector so that no signal is received and turn SYNC ON G off, and then reconnect the signal.</li> </ul>
<b>P. IN P. INPUT</b>	<p><b>P. IN P. screen (*) input signal selection:</b> VIDEO  ⇌  S-VIDEO</p> <p>Selects the signal displayed on the P. IN P. subscreen.</p>
<b>P. IN P. POSIT</b>	<p><b>P. IN P. screen (*) display position selection:</b></p> <p> </p> <p>Selects the position at which the P. IN P. subscreen is displayed.</p>

(\*) The P. IN P. (picture-in-picture) function displays the video signal image in a subscreen (P. IN P. screen) on top of the screen on which the RGB signal image is being displayed. (See "Displaying Child Window" Vol.1



## AUTO Menu

With the AUTO menu, the four items shown in the Table below can be performed.

Please perform each operation in accordance with the instructions in the Table.

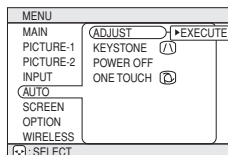

Example : AUTO Menu (ADJUST)

## AUTO Menu

Item	Description
ADJUST	<p><b>Auto Adjust (for RGB):</b> Automatically adjusts H POSITION, V POSITION, H PHASE, and H SIZE. Use this function with the maximum window size.</p> <p><b>Auto Adjust (for VIDEO/S-VIDEO):</b> This function automatically selects the appropriate signal mode depending on input signals. This is only performed if AUTO is selected on the VIDEO menu item (4) of the INPUT menu.</p> <ul style="list-style-type: none"> <li>• This function may not be available with a PAL60 signal and certain other signals.</li> <li>• The AUTO mode operation requires approximately 10 seconds.</li> <li>• For COMPONENT VIDEO, the signal type is identified automatically even if this function is inactive. For more information on HDTV signals, see HDTV. (4)</li> </ul>
KEYSTONE (A)	<p><b>Automatic keystone distortion correction:</b></p> <p>You can automatically correct vertical keystone distortion corresponding to the angle (forward/backward tilt) at which the unit is set up.</p> <ul style="list-style-type: none"> <li>• If the projection screen is inclined, or if the projector is angled downwards, it may not be possible to make the correct adjustment when V: INVERT or H&amp;V: INVERT is selected under the MIRROR item of the MAIN menu.</li> <li>• When the zoom adjustment is set to the TELE side, automatic correction may be excessive. The automatic correction function should be used with zoom set to WIDE whenever possible.</li> </ul>
POWER OFF	<p><b>Adjust POWER OFF Time:</b></p> <p>Long (MAX. 99 min.) [ ] ⇔ [ ] Short (Min. 1 min.) [ ] ⇔ [ ] (DISABLE: 0 min.)</p> <p>If the time set here passes without valid signal input (there is no signal input, or signal input is out of specifications), the standby mode is set (see "TURNING ON THE POWER" Vol.1 15 ). This function is inactive when DISABLE (0 min.) is selected.</p>
ONE TOUCH (B)	<p><b>Enabling/disabling the KEYSTONE (A) function using the ONE TOUCH (B) button:</b></p> <p>TURN ON [ ] ⇔ [ ] TURN OFF</p> <p>Pressing the ONE TOUCH button will automatically retrieve pictures and automatically adjust the screen (see "ADJUSTING SCREEN WITH ONE-TOUCH" Vol.1 23 ), and you can also set the function to execute KEYSTONE (A) (see above in this table) simultaneously when pressed. KEYSTONE will be executed if TURN ON is selected.</p>

# MULTIFUNCTIONAL SETTINGS (continued)

## SCREEN Menu

With the SCREEN menu, the five items shown in the Table below can be performed. Please perform each operation in accordance with the instructions in the Table.

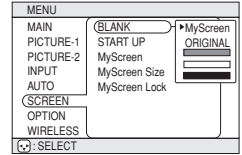

Example : SCREEN Menu (BLANK)

## SCREEN Menu

Item	Description
<b>BLANK</b>	<p><b>Selection of BLANK Screen:</b>                      MyScreen  ⇌  ORIGINAL  ⇌  .  .  ⇌  .  .  ⇌  .  .</p> <p>The BLANK Screen may be voluntarily selected. The BLANK Screen is displayed when the screen has been erased (i.e., made to vanish) by manipulating the BLANK button (please refer to the "Temporarily Blanking the Screen" section of the separate booklet, Vol. 1 (Basic)).</p> <p><b>MyScreen:</b> Using the MyScreen category (see this Table, below), one can register a desired screen (or screens). At the time of factory shipment, this is set as a non-patterned (plain) blue color screen.</p> <p><b>ORIGINAL:</b> Existing standard screens. Please make confirmation using the actual screen(s).</p> <p><b>Option screens:</b> Various colored non-patterned (plain) screens displayed within the Menus.</p> <ul style="list-style-type: none"> <li>• The MyScreen and the ORIGINAL Screen will each change to a non-patterned (plain) black color screen several minutes after being displayed.</li> </ul>
<b>START UP</b>	<p><b>Selection of START UP Screen:</b> MyScreen  ⇌  ORIGINAL  ⇌  TURN OFF</p> <p>The START UP Screen may be voluntarily selected. The START UP Screen is displayed when no signal has been inputted, or when spec signals are being inputted.</p> <p><b>MyScreen:</b> Using the MyScreen category (see this Table, below), one can register a desired screen (or screens). At the time of factory shipment, this is set as a non-patterned (plain) blue color screen.</p> <p><b>ORIGINAL:</b> Existing standard screens. Please make confirmation using the actual screen(s).</p> <p><b>TURN OFF:</b> A non-patterned (plain) blue color screen.</p> <ul style="list-style-type: none"> <li>• The MyScreen and ORIGINAL screens will switch to the BLANK screen (see above in this table) a few minutes after being displayed. If the BLANK screen is the MyScreen or ORIGINAL screen, it will turn immediately to a solid black screen.</li> </ul>
<b>MyScreen</b>	<p><b>Registration of MyScreen:</b>                      When this item is executed, the MyScreen Menu for registration of MyScreen for the BLANK Screen and the START UP Screen is displayed. When operations are performed in accordance with this Menu, one can "cut" and register desired screens from among the received images within the display.</p> <ol style="list-style-type: none"> <li>1. After the "Do you start capturing this picture?" message has been displayed, pressing the ESC (or RESET) button interrupts execution of the MyScreen. When the ENTER button is pressed, the picture becomes static (no longer moves), and a frame for picture cutting, as well as the message that follows below, appear. Please press the button when the screen you want to register is currently being displayed.</li> <li>2. When the "Move the capture area as you want." message has been displayed, pressing the ESC (or RESET) button will eliminate the static state of the picture, and operations can be performed again from operation 1.                      The frame can be moved using the  ,  ,  ,  buttons. After designating the screen you want to register, pressing the ENTER button will initiate screen registration. The registration process takes approximately 1 minute to complete.</li> <li>3. When the registration has been completed, the screen of the registered MyScreen, plus the message, "MyScreen registration is finished," will be displayed for several seconds, after which the operation is terminated.</li> </ol>
<b>MyScreen Size</b>	<b>Selection of MyScreen display size:</b> x1  ⇌  FULL
<b>MyScreen Lock</b>	<p><b>Invalidation of MyScreen registration function:</b> TURN ON  ⇌  TURN OFF</p> <p>When TURN ON is selected, the MyScreen category (see this Table, above) cannot be executed; in this way, one can prohibit rewrites ("writeovers") of the MyScreen.</p>

## OPTION Menu

With the OPTION menu, the five items shown in the Table below can be performed.

Please perform each operation in accordance with the instructions in the Table.

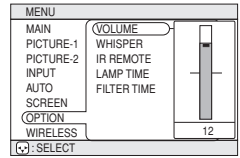

Example : OPTION Menu (VOLUME)

## OPTION Menu

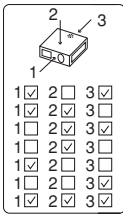
Item	Description
<b>VOLUME</b>	<b>Adjust Volume:</b> High <input type="button" value="▲"/> ↔ <input type="button" value="▼"/> Low
<b>WHISPER</b>	<b>Select WHISPER Mode:</b> NORMAL <input type="button" value="▼"/> ↔ <input type="button" value="▲"/> WHISPER When WHISPER is selected the WHISPER mode is activated. In the WHISPER mode, acoustic noise and screen brightness are reduced.
<b>IR REMOTE</b>	<b>Selecting the remote control receiver:</b> The unit has 3 remote control receivers, as shown in the figure to the right (1, 2, and 3). You can select which of them to activate ("v" in the figure), and which to disable. <ul style="list-style-type: none"> <li>The ambient lighting and other factors may prevent the remote control operation from functioning properly. If this happens, use this function to disable receivers being impacted by unneeded light.</li> </ul> 
<b>LAMP TIME</b>	<b>Refer to LAMP TIME:</b> When set, this function displays the total time the projector lamp has been used since new. <b>Reset LAMP TIME [Use this function only when the lamp has been replaced!]:</b> Depress the RESET button for at least 3 seconds while lamp time is being displayed. The reset menu will then appear. After you replace the lamp with a new lamp, select RESET on the menu with the <input type="button" value="▲"/> button. <ul style="list-style-type: none"> <li>Do not reset the lamp time unless you have replaced the lamp. And, always reset the lamp time when replacing the lamp. The message functions will not operate properly if the lamp time is not reset correctly.</li> <li>Before replacing the lamp, carefully read the descriptions headed "THE LAMP".</li> </ul>
<b>FILTER TIME</b>	<b>Refer to FILTER TIME:</b> This function displays the total time the air-filter has been used since new. <b>Reset FILTER TIME [Use this function only when the filter is cleaned or replaced!]:</b> Depress the RESET button for at least 3 seconds while lamp time is being displayed. The reset menu will then appear. After you replace the filter, select RESET on the menu with the <input type="button" value="▲"/> button. RESET <input type="button" value="▲"/> ↔ <input type="button" value="▼"/> CANCEL <ul style="list-style-type: none"> <li>Do not reset the filter time unless you have cleaned or replaced the filter. And, always reset the filter time when cleaning or replacing the filter. The message functions will not operate properly if the filter time is not reset correctly.</li> <li>Before cleaning or replacing the filter, carefully read the descriptions headed "THE AIR FILTER".</li> </ul>

## WIRELESS Menu

The WIRELESS menu is only enabled if the wireless function is enabled. Using the wireless function requires a Wireless & Network Module Terminal (sold separately). See the Wireless & Network Module Terminal user's manual for more information about the WIRELESS menu. Contact your local dealer for more information about the wireless function and Wireless & Network Module Terminal.

# WHAT TO DO WHEN YOU THINK A MACHINE DEFECT HAS OCCURRED

## Related Messages

When the unit's power is ON, messages such as those shown below may be displayed. When any such message is displayed on the screen, please respond as described below.

Message	Description
<b>CHANGE THE LAMP AFTER REPLACING LAMP, RESET THE LAMP TIMER.</b> (Note 1)	Lamp usage time is approaching 2,000 hours. (Note 2) Preparation of a new lamp, and an early lamp change, is recommended. After you have changed the lamp, please be sure to reset the lamp timer.
<b>CHANGE THE LAMP AFTER REPLACING LAMP, RESET THE LAMP TIMER. THE POWER WILL TURN OFF AFTER ** hr.</b> (Note 1)	Lamp usage time is approaching 2,000 hours. A lamp change within ** hours is recommended. (Note 2) When lamp usage reaches 2,000 hours, the power will automatically be turned OFF. Please change the lamp by referring to "THE LAMP" (Vol.1 <b>27</b> ). After you have changed the lamp, please be sure to reset the lamp timer.
<b>CHANGE THE LAMP AFTER REPLACING LAMP, RESET THE LAMP TIMER. THE POWER WILL TURN OFF AFTER 0 hr.</b>	As lamp use has reached 2,000 hours, the power will soon be automatically turned OFF. (Note 2) Please immediately turn the power OFF, and follow the instructions in the "THE LAMP" (Vol.1 <b>27</b> ). After you have changed the lamp, please be sure to reset the lamp timer. ( <b>7</b> )
<b>CLEAN THE AIR FILTER AFTER CLEANING AIR FILTER, RESET THE FILTER TIMER.</b>	A note of precaution when cleaning the air filter. After cleaning the filter, operate FILTER TIME of the OPTION Menu ( <b>7</b> ), and perform reset of the filter timer.
<b>NO INPUT IS DETECTED ON ***</b>	There is no input signal. Please confirm the signal input connection, and the status of the signal source.
<b>SYNC IS OUT OF RANGE</b> ON *** <b>fH</b> *****kHz <b>fV</b> *****Hz	The horizontal or vertical wavelength of the inputted signal is outside of the response parameters of this unit. Please confirm the specs for this unit or the signal source specs.
<b>CHECK THE AIR FLOW</b>	The internal portion temperature is rising. Please turn the power OFF, and allow the unit to cool down for approximately 20 minutes. After having confirmed the following items, then please resent the power to ON. <ul style="list-style-type: none"> <li>• Is there blockage of the air passage aperture?</li> <li>• Is the air filter dirty?</li> <li>• Does the peripheral temperature exceed 35°C?</li> </ul>

### NOTES

Note 1: Although this message will be automatically disappeared after around 3 minutes, it will be reappeared every time the power is turned ON.

Note 2: Lamps have a finite product life. Lamps are characterized by the fact that, after long hours of usage, a lamp will no longer light up, or the lamp will break or burst, etc. This unit is equipped with an automatic shut-down function, such that the power will automatically be turned OFF when lamp usage time has reached 2,000 hours. Please be aware, however, that among lamp types, there are major differences in product lifetimes; a lamp may thus fail to light even prior to the functioning of the automatic shut-down function of this unit.

## Regarding the Indicator Lamps

Lighting and flashing of the POWER indicator, the LAMP indicator, and the TEMP indicator have the meanings as described in the Table below. Please respond in accordance with the instructions within the Table.

POWER indicator	LAMP indicator	TEMP indicator	Description
The orange lamp is lighted	Turned OFF (Not lighted)	Turned OFF (Not lighted)	The STANDBY mode is set
Flashing of the green lamp	Turned OFF	Turned OFF	The unit is warming up. Please wait.
The green lamp is lighted	Turned OFF	Turned OFF	The unit is in an ON state. Ordinary operations may be performed.
Flashing of the orange lamp	Turned OFF	Turned OFF	The unit is cooling down. Please wait.
Blinking of the red lamp	-	-	The unit is cooling down. Please wait. A certain error has been detected. Wait until the POWER indicator lamp has finished flashing, and then perform the proper response measure using the item descriptions below as reference.
The red lamp is lighted, or blinks	The red lamp is lighted	Turned OFF	The lamp does not light. There is a possibility that the interior portion has become heated. Turn the power OFF and wait approximately 20 minutes. After the main unit has cooled down, please confirm whether or not there is blockage of the air passage aperture, whether or not the filter is dirty, and/or whether or not the peripheral temperature exceeds 35°C, etc. After performing any needed maintenance, turn the power ON again; if the same display is displayed, then please change the lamp.
The red lamp is lighted, or blinks	Blinking of the red lamp	Turned OFF	Either there is no lamp and/or lamp cover, or either of these has not been properly fixed (attached). Turn the power OFF and wait approximately 45 minutes. After the main unit has sufficiently cooled down, please make confirmation of the attachment state of the lamp and lamp cover. After performing any needed maintenance, turn the power ON again; if the same display is displayed, then please contact a sales store or a service company.
The red lamp is lighted, or blinks	Turned OFF	Blinking of the red lamp	The cooling fan is not operating. Turn the power OFF and wait approximately 20 minutes. After the main unit has cooled down, please make confirmation that no foreign matter has become caught in the fan, etc. After performing any needed maintenance, turn the power ON again; if the same display is displayed, then please contact a sales store or a service company.
The red lamp is lighted, or blinks	Turned OFF	The red lamp is lighted	There is a possibility that the interior portion has become heated. Turn the power OFF and wait approximately 20 minutes. After the main unit has cooled down, please confirm whether or not there is blockage of the air passage aperture, whether or not the filter is dirty, and/or whether or not the peripheral temperature exceeds 35°C, etc. After performing any needed maintenance, turn the power ON again; if the same display is displayed, then please contact a sales store or a service company.
The green lamp is lighted	Alternative blinking with the red lamp		There is a possibility that the interior portion has become overcooled. Please use the unit within the usage temperature parameters (0°C to 35°C). After performing any needed maintenance, turn the power ON again; if the same display is displayed, then please contact a sales store or a service company.
The green lamp is lighted	Simultaneous blinking with the red lamp		This is a notification that it is time to clean the filter. After cleaning the filter, operate the FILTER TIME portion of the OPTION Menu, and perform reset of the FILTER TIME.

### NOTE

When the interior portion has become overheated, for safety purposes, the power source is automatically turned OFF, and the indicator lamps may also be turned OFF. Press the "○" (power OFF) side of the main power switch, and wait for approximately 20 minutes. Please then use the unit only after having first confirmed that the unit has sufficiently cooled down.

## WHAT TO DO WHEN YOU THINK A MACHINE DEFECT HAS OCCURRED (continued)

### Phenomena That May Easily Be Mistaken for Machine Defects

Before requesting repair, check in accordance with the following chart.

If the situation cannot be corrected, then contact your dealer.

Phenomenon	Cases not involving a machine defect	Items to be confirmed	Reference Page(s)
Power does not come ON	The main power source is not ON.	Turn on the main power.	Vol.1-3, 15
	The electrical power cord is not plugged in.	Correctly connect the power cord.	
	The main power source has been interrupted during operation, such as by a power outage (blackout), etc.	Be sure to press the "O" (power OFF) side of the main power switch, and leave this OFF for approximately 20 minutes. After the unit has sufficiently cooled down, turn ON the power source.	Vol.1-15
No sound or pictures are outputted	The input changeover settings are mismatched.	Select the input signal, and correct the settings.	Vol.1-16
	No signal is being inputted.	Correctly connect the connection cord.	Vol.1-8-12
Pictures are displayed, but no sounds are heard	The electrical wiring to this unit is not correctly connected.	Correctly connect the connection cord.	Vol.1-8-12
	The volume setting has been set at (or adjusted to) an extremely low level.	Adjust the VOLUME setting to a higher level.	Vol.1-18
	The MUTE mode is the current setting.	Press the MUTE button to release (change) the MUTE mode setting.	Vol.1-18
Sounds are heard, but no pictures are displayed	The electrical wiring to this unit is not correctly connected.	Correctly connect the connection cord.	Vol.1-8-12
	The brightness setting has been set at (or adjusted to) an extremely low level.	Adjust the BRIGHT setting to a brighter level.	Vol.2-2
	The lens cap has not been removed.	Remove the lens cap.	Vol.1-15
Colors have a faded-out appearance Color tone is poor	Color depth setting or color tone setting	Perform picture adjustments by changing the COLOR BAL R, the COLOR BAL B, and/or the TINT settings, etc.	Vol.2-3
Pictures appear dark	The brightness setting and/or contrast setting has not been properly adjusted.	Perform picture adjustments by changing the BRIGHT and/or CONTRAST settings, etc.	Vol.2-2
	The WHISPER mode is the current setting.	Change (by releasing) from the WHISPER mode.	Vol.2-7
	Lamp is approaching the end of its product lifetime.	Exchange the old lamp with a new lamp.	Vol.1-27, 28
Pictures appear blurry	Either the FOCUS setting or the H PHASE is not properly adjusted.	Adjust the FOCUS and H PHASE settings.	Vol.1-16 Vol.2-3
Input signal changes with no-operation.	INPUT dial is set between the click points.	Turn the INPUT dial and set it at the click point.	Vol.1-16

#### NOTE

Although bright spots or dark spots may appear on the screen, this is a unique characteristic of liquid crystal displays, and such do not constitute or imply a machine defect.

# SPECIFICATIONS

**NOTE** • This specifications are subject to change without notice.

Item		Specification
Product name		Liquid crystal projector
Liquid crystal panel	Panel size	2.5 cm (0.99 type)
	Drive system	TFT active matrix
	Pixels	786,432 pixels (1024 horizontal x 768 vertical)
Lens		Zoom lens F=1.7 ~ 2.4 f=30.5 ~ 45.8 mm
Lamp		275 W UHB
Speaker		1.0W+1.0W (Stereo)
Power supply		AC100 ~ 120V, 4.7A / AC220 ~ 240V, 2.0A
Power consumption		430W
Temperature range		0 ~ 35°C (Operating)
Size		380 (W) x 120 (H) x 290 (D) mm (Not including protruding parts)
Weight (mass)		5.7 kg
Ports	<p><b>RGB Input Ports</b>            RGB ..... 1            BNC (when RGB selected)            – (R.G.B.H.V) ..... 1            DVI ..... 1</p> <p><b>VIDEO Input Ports</b>            VIDEO IN ..... 1            S-VIDEO IN ..... 1            COMPONENT VIDEO            – (Cr/Pr, Cb/Pb, Y) ..... 1            BNC            (when COMPONENT selected)            – (Cr/Pr, Y, Cb/Pb) ..... 1</p>	<p><b>AUDIO Ports</b>            AUDIO IN 1 ..... 1            AUDIO IN 2 ..... 1            AUDIO IN (R, L) ..... 1</p> <p><b>RGB Output Port</b>            RGB OUT ..... 1</p> <p><b>AUDIO Output Port</b>            AUDIO OUT ..... 1</p> <p><b>CONTROL Ports</b>            CONTROL ..... 1            USB ..... 1</p> <p><b>Other Ports</b>            WIRELESS &amp; NETWORK MODULE.... 1            REMOTE CONTROL ..... 1</p>
Optional Parts	Lamp: DT00531 Air Filter: NJ07081 * For others, consult your dealer.	

## Dimension Diagram

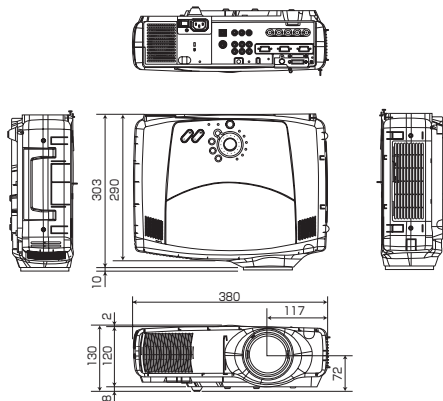

Unit : mm

## WARRANTY AND AFTER-SERVICE

If a problem occurs with the equipment, first refer to the **8** “WHAT TO DO WHEN YOU THINK A MACHINE DEFECT HAS OCCURRED” section and run through the suggested checks. If this does not resolve the problem contact your dealer or service company. They will tell you what warranty condition is applied.



# TECHNICAL

## SIGNAL CONNECTOR PIN ASSIGNMENT

RGB IN [1]/[2]  
RGB OUT



D-sub 15-pin Shrink

S-VIDEO

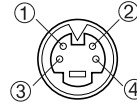

Mini Din 4-pin

Pin No	Signal	Pin No	Signal
1	Video input Red	9	-
2	Video input Green	10	Ground
3	Video input Blue	11	-
4	-	12	RGB IN [1]: SDA (DDC)
5	Ground		RGB IN [2]: -
6	Ground Red		RGB OUT : -
7	Ground Green	13	H. sync./ Composite sync.
8	Ground Blue	14	Vertical sync
		15	RGB IN [1]: SCL (DDC)
			RGB IN [2]: -
			RGB OUT : -

Mini Din 4-pin	
Pin No	Signal
1	Color: 0.286Vp-p (NTSC, burst signal), 75Ω terminator 0.3Vp-p (PAL/SECAM, burst signal), 75Ω terminator
2	Brightness: 1.0Vp-p, 75Ω terminator
3	Ground
4	Ground

signal	Terminal	Specification
RGB signal input	RGB	Video: RGB separate, Analog, 0.7Vp-p, 75Ω terminator (positive) H/V. sync.: TTL level (positive/negative) Composite sync.: TTL level D-sub 15-pin shrink jack
	BNC (RGB) (R,G,B,H,V)	Video: RGB separate, Analog 0.7Vp-p, 75Ω terminator (positive) H/V. sync.: TTL level (positive/negative) Composite sync.: TTL level BNC connector x 5
	DVI	TMDS, DC 150-1200 mV/AC 1.56 Vp-p, TTL Level (Positive/Negative) DVI connector
	AUDIO IN 1	200mVrms, 57Ω (max. 3.0Vp-p)
	AUDIO IN 2	Stereo mini jack
Video signal input	VIDEO IN	1.0Vp-p, 75Ω terminator, RCA jack
	S-VIDEO IN	Brightness signal: 1.0Vp-p, 75Ω terminator Color signal: 0.286Vp-p (NTSC, burst signal), 75Ω terminator Color signal: 0.300Vp-p (PAL/SECAM, burst signal), 75Ω terminator Mini DIN 4-pin jack
	COMPONENT VIDEO (Cr/Pr, Cb/Pb, Y)	Y signal: 1.0 Vp-p, 75 Ω terminator Cr/Pr signal: 0.7 Vp-p, 75 Ω terminator Cb/Pb signal: 0.7 Vp-p, 75 Ω terminator RCA jack x 3 (BNC connector x 5)
	BNC (COMPONENT) (Cr/Pr, Cb/Pb, Y)	
	AUDIO IN (R, L)	200mVrms, 50 kΩ (max. 3.0Vp-p) RCA jack
Signal output	RGB OUT	Video: RGB separate, Analog 0.7Vp-p, 75Ω (positive) Sync.: H,V separate, TTL level (positive/negative) Composite sync.: TTL level D-sub 15-pin shrink jack
	AUDIO OUT	200mV(rms), output impedance 1kΩ (max. 3.0Vp-p) Stereo mini jack
Control functions	CONTROL	D-sub 15pin shrink plug
	USB	USB jack (B type)

## EXAMPLE OF COMPUTER SIGNAL

Resolution H × V	fH (kHz)	fV (Hz)	Rating	Signal mode	Display mode	
					CP-X880	CP-X885
720 × 400	37.9	85.0	VESA	TEXT	Zoom in	Zoom in
640 × 480	31.5	59.9	VESA	VGA (60Hz)	Zoom in	Zoom in
640 × 480	35.0	66.7		Mac13"mode	Zoom in	Zoom in
640 × 480	37.9	72.8	VESA	VGA (72Hz)	Zoom in	Zoom in
640 × 480	37.5	75.0	VESA	VGA (75Hz)	Zoom in	Zoom in
640 × 480	43.3	85.0	VESA	VGA (85Hz)	Zoom in	Zoom in
800 × 600	35.2	56.3	VESA	SVGA (56Hz)		Zoom in
800 × 600	37.9	60.3	VESA	SVGA (60Hz)		Zoom in
800 × 600	48.1	72.2	VESA	SVGA (72Hz)		Zoom in
800 × 600	46.9	75.0	VESA	SVGA (75Hz)		Zoom in
800 × 600	53.7	85.1	VESA	SVGA (85Hz)		Zoom in
832 × 624	49.7	74.5		Mac16"mode	Zoom out	Zoom in
1024 × 768	48.4	60.0	VESA	XGA (60Hz)	Zoom out	
1024 × 768	56.5	70.1	VESA	XGA (70Hz)	Zoom out	
1024 × 768	60.0	75.0	VESA	XGA (75Hz)	Zoom out	
1024 × 768	68.7	85.0	VESA	XGA (85Hz)	Zoom out	
1152 × 864	67.5	75.0	VESA	SXGA (75Hz)	Zoom out	Zoom out
1280 × 960	60.0	60.0	VESA	SXGA (60Hz)	Zoom out	Zoom out
1280 × 1024	64.0	60.0	VESA	SXGA (60Hz)	Zoom out	Zoom out
1280 × 1024	80.0	75.0	VESA	SXGA (75Hz)	Zoom out	Zoom out
1280 × 1024	91.2	85.0	VESA	SXGA (85Hz)	Zoom out	Zoom out
1600 × 1200	75.0	60.0	VESA	UXGA (60Hz)	Zoom out	Zoom out

- NOTE** • Some computers may have multiple display screen modes. Use of some of these modes will not be possible with this projector.
- Be sure to check jack type, signal level, timing and resolution before connecting this projector to a computer.
  - Depending on the input signal, full-size display may not be possible in some cases. Refer to the number of display pixels above.
  - Although the projector can display signals (except DVI input) with resolution up to UXGA (1,600 × 1,200), the signal will be converted to the projector's panel resolution before being displayed. The best display performance will be achieved if the resolutions of the input signal and projector panel are identical.
  - The image may not be displayed correctly when the input sync. signal is "Composite Sync." or "Sync. on G".
  - UXGA (1,600 × 1,200) signals cannot be displayed with DVI input.

# INITIAL SET SIGNALS

The following signals are used for the initial settings.

The signal timing of some computer models may be different. In such case, refer to adjust the V.POSIT and H.POSIT of the menu.

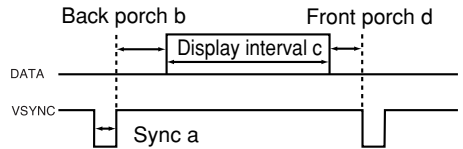
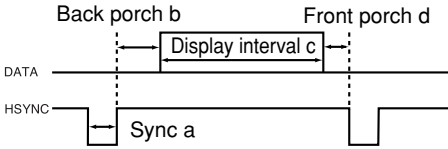

Computer / Signal	Horizontal signal timing ( $\mu$ s)			
	a	b	c	d
TEXT	2.0	3.0	20.3	1.0
VGA (60Hz)	3.8	1.9	25.4	0.6
Mac 13"mode	2.1	3.2	21.2	2.1
VGA (72Hz)	1.3	3.8	20.3	1.0
VGA (75Hz)	2.0	3.8	20.3	0.5
VGA (85Hz)	1.6	2.2	17.8	1.6
SVGA (56Hz)	2.0	3.6	22.2	0.7
SVGA (60Hz)	3.2	2.2	20.0	1.0
SVGA (72Hz)	2.4	1.3	16.0	1.1
SVGA (75Hz)	1.6	3.2	16.2	0.3
SVGA (85Hz)	1.1	2.7	14.2	0.6
Mac 16"mode	1.1	3.9	14.5	0.6
XGA (60Hz)	2.1	2.5	15.8	0.4
XGA (70Hz)	1.8	1.9	13.7	0.3
XGA (75Hz)	1.2	2.2	13.0	0.2
XGA (85Hz)	1.0	2.2	10.8	0.5
1152x864 (75Hz)	1.2	2.4	10.7	0.6
1280x960 (60Hz)	1.0	2.9	11.9	0.9
1280x1024 (60Hz)	1.0	2.3	11.9	0.4
1280x1024 (75Hz)	1.1	1.8	9.5	0.2
1280x1024 (85Hz)	1.0	1.4	8.1	0.4
1600x1200 (60Hz)	1.2	1.9	9.9	0.4

Computer / Signal	Vertical signal timing (lines)			
	a	b	c	d
TEXT	3	42	400	1
VGA (60Hz)	2	33	480	10
Mac 13"mode	3	39	480	3
VGA (72Hz)	3	28	480	9
VGA (75Hz)	3	16	480	1
VGA (85Hz)	3	25	480	1
SVGA (56Hz)	2	22	600	1
SVGA (60Hz)	4	23	600	1
SVGA (72Hz)	6	23	600	37
SVGA (75Hz)	3	21	600	1
SVGA (85Hz)	3	27	600	1
Mac 16"mode	3	39	624	1
XGA (60Hz)	6	29	768	3
XGA (70Hz)	6	29	768	3
XGA (75Hz)	3	28	768	1
XGA (85Hz)	3	36	768	1
1152x864 (75Hz)	3	32	864	1
1280x960 (60Hz)	3	36	960	1
1280x1024 (60Hz)	3	38	1024	1
1280x1024 (75Hz)	3	37	1024	2
1280x1024 (85Hz)	3	44	1024	1
1600x1200 (60Hz)	3	46	1200	1

# CONNECTION TO THE MOUSE CONTROL

## ADB Mouse

CONTROL Terminal  
D-sub 15-pin shrink jack

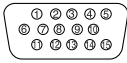

Projector



Computer

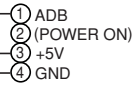

Mouse jack  
Mini DIN 4-pin



## Serial Mouse

CONTROL Terminal  
D-sub 15-pin shrink jack

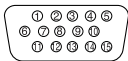

Projector



Computer

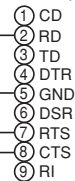

Mouse jack  
D-sub 9-pin

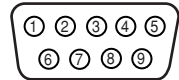

## USB Mouse

USB jack  
(B type)

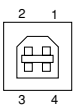

Projector

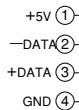

Computer

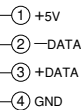

USB jack  
(A type)



USB cable

## PS/2 Mouse

CONTROL Terminal  
D-sub 15-pin shrink jack



Projector



Computer



Mouse jack  
Mini DIN 6-pin



# RS-232C COMMUNICATION

- (1) Turn off the projector and computer power supplies, and connect with the RS-232C adapter via the RS-232C cable.
- (2) Turn on the computer power supply and after the computer has started up, turn on the projector power supply.

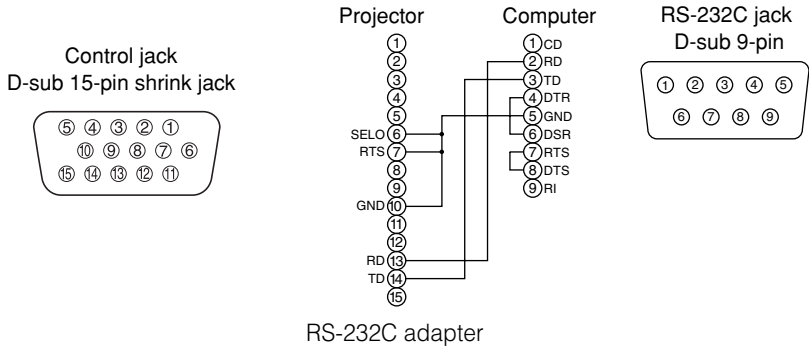

## Communications setting

19200bps, 8N1

### 1 Protocol

Consist of header (7 bytes) + command data (6 bytes).

### 2 Header

BE + EF + 03 + 06 + 00 + CRC\_low + CRC\_high

CRC\_low : Lower byte of CRC flag for command data.

CRC\_high : Upper byte of CRC flag for command data.

### 3 Command data

Command data chart

byte_0	byte_1	byte_2	byte_3	byte_4	byte_5
Action		Type		Setting code	
low	high	low	high	low	high

Action (byte\_0 - 1)

Action	Classification	Content
1	SET	Change setting to desired value.
2	GET	Read projector internal setup value.
4	INCREMENT	Increment setup value by 1.
5	DECREMENT	Decrement setup value by 1.
6	EXECUTE	Run a command.

## RS-232C COMMUNICATION (continued)

### Requesting projector status (Get command)

- (1) Send the request code Header + Command data ('02H'+ '00H'+ type (2 bytes) + '00H'+ '00H') from the computer to the projector.
- (2) The projector returns the response code '1DH'+ data (2 bytes) to the computer.

### Changing the projector settings (Set command)

- (1) Send the setting code Header + Command data ('01H'+ '00H'+ type (2 bytes) + setting code (2 bytes)) from the computer to the projector.
- (2) The projector changes the setting based on the above setting code.
- (3) The projector returns the response code '06H' to the computer.

### Using the projector default settings (Reset Command)

- (1) The computer sends the default setting code Header + Command data ('06H'+ '00H'+ type (2 bytes) + '00H'+ '00H') to the projector.
- (2) The projector changes the specified setting to the default value.
- (3) The projector returns the response code '06H' to the computer.

### Increasing the projector setting value (Increment command)

- (1) The computer sends the increment code Header + Command data ('04H'+ '00H'+ type (2 bytes) + '00H'+ '00H') to the projector.
- (2) The projector increases the setting value on the above setting code.
- (3) The projector returns the response code '06H' to the computer.

### Decreasing the projector setting value (Decrement command)

- (1) The computer sends the decrement code Header + Command data ('05H'+ '00H'+ type (2 bytes) + '00H'+ '00H') to the projector.
- (2) The projector decreases the setting value on the above setting code.
- (3) The projector returns the response code '06H' to the computer.

### When a command sent by the projector cannot be understood by the computer

When the command sent by the projector cannot be understood, the error command '15H' is returned by the computer. Some times, the projector ignores RS-232C commands during other works. If the error command '15H' is returned, please send the same command again.

### When data sent by the projector cannot be practice

When the command sent by the projector cannot be practiced, the the error code '1cH'+ 'xxxxH' is returned.

When the data length is greater than indicated by the data length code, the projector will ignore the excess data code.

Conversely, when the data length is shorter than indicated by the data length code, an error code will be returned to the projector.

- NOTE**
- Operation cannot be guaranteed when the projector receives an undefined command or data.
  - Provide an interval of at least 40ms between the response code and any other code.
  - The projector outputs test data when the power supply is switched ON, and when the lamp is lit. Ignore this data.
  - Commands are not accepted during warm-up.

# Command data chart

Names	Operation type	Header				Command data									
						CRC	Action	Type	Setting code						
Blank Color	Set	Blue	BE	EF	03	06	00	CB	D3	01	00	00	30	03	00
		White	BE	EF	03	06	00	6B	D0	01	00	00	30	05	00
		Black	BE	EF	03	06	00	9B	D0	01	00	00	30	06	00
		MyScreen	BE	EF	03	06	00	FB	CA	01	00	00	30	20	00
		ORIGNAL	BE	EF	03	06	00	FB	E2	01	00	00	30	40	00
	Get	BE	EF	03	06	00	08	D3	02	00	00	30	00	00	
Mirror	Set	Normal	BE	EF	03	06	00	C7	D2	01	00	01	30	00	00
		H Inverse	BE	EF	03	06	00	57	D3	01	00	01	30	01	00
		V Inverse	BE	EF	03	06	00	A7	D3	01	00	01	30	02	00
		H&V Inverse	BE	EF	03	06	00	37	D2	01	00	01	30	03	00
		Get	BE	EF	03	06	00	F4	D2	02	00	01	30	00	00
Freeze	Set	Normal	BE	EF	03	06	00	83	D2	01	00	02	30	00	00
		Freeze	BE	EF	03	06	00	13	D3	01	00	02	30	01	00
		Get	BE	EF	03	06	00	B0	D2	02	00	02	30	00	00
Startup	Set	ORIGNAL	BE	EF	03	06	00	0B	D2	01	00	04	30	00	00
		OFF	BE	EF	03	06	00	9B	D3	01	00	04	30	01	00
		MyScreen	BE	EF	03	06	00	CB	CB	01	00	04	30	20	00
		Get	BE	EF	03	06	00	38	D2	02	00	04	30	00	00
Language	Set	English	BE	EF	03	06	00	F7	D3	01	00	05	30	00	00
		Français	BE	EF	03	06	00	67	D2	01	00	05	30	01	00
		Deutsch	BE	EF	03	06	00	97	D2	01	00	05	30	02	00
		Español	BE	EF	03	06	00	07	D3	01	00	05	30	03	00
		Italiano	BE	EF	03	06	00	37	D1	01	00	05	30	04	00
		Norsk	BE	EF	03	06	00	A7	D0	01	00	05	30	05	00
		Nederlands	BE	EF	03	06	00	57	D0	01	00	05	30	06	00
		Português	BE	EF	03	06	00	C7	D1	01	00	05	30	07	00
		日本語	BE	EF	03	06	00	37	D4	01	00	05	30	08	00
	中文	BE	EF	03	06	00	A7	D5	01	00	05	30	09	00	
한글	BE	EF	03	06	00	57	D5	01	00	05	30	0A	00		
	Get	BE	EF	03	06	00	C4	D3	02	00	05	30	00	00	
Magnify		Get	BE	EF	03	06	00	7C	D2	02	00	07	30	00	00
		Increment	BE	EF	03	06	00	1A	D2	04	00	07	30	00	00
		Decrement	BE	EF	03	06	00	CB	D3	05	00	07	30	00	00
Auto off		Get	BE	EF	03	06	00	08	86	02	00	10	31	00	00
		Increment	BE	EF	03	06	00	6E	86	04	00	10	31	00	00
		Decrement	BE	EF	03	06	00	BF	87	05	00	10	31	00	00
Brightness Reset		Execute	BE	EF	03	06	00	58	D3	06	00	00	70	00	00
Contrast Reset		Execute	BE	EF	03	06	00	A4	D2	06	00	01	70	00	00
V.Position Reset		Execute	BE	EF	03	06	00	E0	D2	06	00	02	70	00	00

## Command data chart (continued)

Names	Operation type		Header				Command data		
							CRC	Action	Type
H.Position Reset	Execute		BE EF 03 06 00	IC D3	06 00	03 70	00 00		
H.Size Reset	Execute		BE EF 03 06 00	68 D2	06 00	04 70	00 00		
Color Balance R Reset	Execute		BE EF 03 06 00	94 D3	06 00	05 70	00 00		
Color Balance B Reset	Execute		BE EF 03 06 00	D0 D3	06 00	06 70	00 00		
Sharpness Reset	Execute		BE EF 03 06 00	C4 D0	06 00	09 70	00 00		
Color Reset	Execute		BE EF 03 06 00	80 D0	06 00	0A 70	00 00		
Tint Reset	Execute		BE EF 03 06 00	7C D1	06 00	0B 70	00 00		
Keystone_V Reset	Execute		BE EF 03 06 00	08 D0	06 00	0C 70	00 00		
Keystone_H Reset	Execute		BE EF 03 06 00	98 D8	06 00	20 70	00 00		
Auto Adjust	Execute		BE EF 03 06 00	91 D0	06 00	0A 20	00 00		
Auto Keystone_V	Execute		BE EF 03 06 00	E5 D1	06 00	0D 20	00 00		
Lamp Time Reset	Execute		BE EF 03 06 00	58 DC	06 00	30 70	00 00		
Filter Time Reset	Execute		BE EF 03 06 00	98 C6	06 00	40 70	00 00		
Blank on/off	Set	off	BE EF 03 06 00	FB D8	01 00	20 30	00 00		
		on	BE EF 03 06 00	6B D9	01 00	20 30	01 00		
	Get	BE EF 03 06 00	C8 D8	02 00	20 30	00 00			
Error Status	Get	(Example of Return)							
		00 00 01 00 02 00 03 00 (Normal) (Cover-error) (Fan-error) (Lamp-error) 04 00 05 00 06 00 07 00 08 00 (Temp-error) (Air flow-error) (Lamp-Time-over) (Cool-error) (Filter-Error)							
Power	Set	OFF	BE EF 03 06 00	2A D3	01 00	00 60	00 00		
		ON	BE EF 03 06 00	BA D2	01 00	00 60	01 00		
	Get	BE EF 03 06 00	19 D3	02 00	00 60	00 00			
Input Source	Set	RGB	BE EF 03 06 00	FE D2	01 00	00 20	00 00		
		BNC (RGB)	BE EF 03 06 00	3E D0	01 00	00 20	04 00		
		Video	BE EF 03 06 00	6E D3	01 00	00 20	01 00		
		S-Video	BE EF 03 06 00	9E D3	01 00	00 20	02 00		
		Component	BE EF 03 06 00	AE D1	01 00	00 20	05 00		
		DVI	BE EF 03 06 00	0E D2	01 00	00 20	03 00		
	BNC (Component)	BE EF 03 06 00	5E D1	01 00	00 20	06 00			
Get	BE EF 03 06 00	CD D2	02 00	00 20	00 00				
Volume	Get	BE EF 03 06 00	31 D3	02 00	01 20	00 00			
	Increment	BE EF 03 06 00	57 D3	04 00	01 20	00 00			
	Decrement	BE EF 03 06 00	86 D2	05 00	01 20	00 00			
Mute	Set	Normal	BE EF 03 06 00	46 D3	01 00	02 20	00 00		
		Mute	BE EF 03 06 00	D6 D2	01 00	02 20	01 00		
	Get	BE EF 03 06 00	75 D3	02 00	02 20	00 00			
Brightness	Get	BE EF 03 06 00	89 D2	02 00	03 20	00 00			
	Increment	BE EF 03 06 00	EF D2	04 00	03 20	00 00			
	Decrement	BE EF 03 06 00	3E D3	05 00	03 20	00 00			
Contrast	Get	BE EF 03 06 00	FD D3	02 00	04 20	00 00			
	Increment	BE EF 03 06 00	9B D3	04 00	04 20	00 00			
	Decrement	BE EF 03 06 00	4A D2	05 00	04 20	00 00			
Color Balance R	Get	BE EF 03 06 00	01 D2	02 00	05 20	00 00			
	Increment	BE EF 03 06 00	67 D2	04 00	05 20	00 00			
	Decrement	BE EF 03 06 00	B6 D3	05 00	05 20	00 00			



Names	Operation type		Header			Command data		
						CRC	Action	Type
Color Balance B	Get		BE EF 03 06 00	45 D2	02 00	06 20	00 00	
	Increment		BE EF 03 06 00	23 D2	04 00	06 20	00 00	
	Decrement		BE EF 03 06 00	F2 D3	05 00	06 20	00 00	
Keystone_V	Get		BE EF 03 06 00	B9 D3	02 00	07 20	00 00	
	Increment		BE EF 03 06 00	DF D3	04 00	07 20	00 00	
	Decrement		BE EF 03 06 00	0E D2	05 00	07 20	00 00	
Keystone_H	Get		BE EF 03 06 00	E9 D0	02 00	0B 20	00 00	
	Increment		BE EF 03 06 00	8F D0	04 00	0B 20	00 00	
	Decrement		BE EF 03 06 00	5E D1	05 00	0B 20	00 00	
Aspect	Set	4:3	BE EF 03 06 00	9E D0	01 00	08 20	00 00	
		16:9	BE EF 03 06 00	0E D1	01 00	08 20	01 00	
		Small	BE EF 03 06 00	FE D1	01 00	08 20	02 00	
	Get		BE EF 03 06 00	AD D0	02 00	08 20	00 00	
Picture Position at 16 : 9 or Small	Set	Default	BE EF 03 06 00	62 D1	01 00	09 20	00 00	
		Bottom	BE EF 03 06 00	F2 D0	01 00	09 20	01 00	
		Top	BE EF 03 06 00	02 D0	01 00	09 20	02 00	
	Get		BE EF 03 06 00	51 D1	02 00	09 20	00 00	
V.Position	Get		BE EF 03 06 00	0D 83	02 00	00 21	00 00	
	Increment		BE EF 03 06 00	6B 83	04 00	00 21	00 00	
	Decrement		BE EF 03 06 00	BA 82	05 00	00 21	00 00	
H.Position	Get		BE EF 03 06 00	F1 82	02 00	01 21	00 00	
	Increment		BE EF 03 06 00	97 82	04 00	01 21	00 00	
	Decrement		BE EF 03 06 00	46 83	05 00	01 21	00 00	
H.Size	Get		BE EF 03 06 00	B5 82	02 00	02 21	00 00	
	Increment		BE EF 03 06 00	D3 82	04 00	02 21	00 00	
	Decrement		BE EF 03 06 00	02 83	05 00	02 21	00 00	
H.Phase	Get		BE EF 03 06 00	49 83	02 00	03 21	00 00	
	Increment		BE EF 03 06 00	2F 83	04 00	03 21	00 00	
	Decrement		BE EF 03 06 00	FE 82	05 00	03 21	00 00	
Sharpness	Get		BE EF 03 06 00	F1 72	02 00	01 22	00 00	
	Increment		BE EF 03 06 00	97 72	04 00	01 22	00 00	
	Decrement		BE EF 03 06 00	46 73	05 00	01 22	00 00	
Color	Get		BE EF 03 06 00	B5 72	02 00	02 22	00 00	
	Increment		BE EF 03 06 00	D3 72	04 00	02 22	00 00	
	Decrement		BE EF 03 06 00	02 73	05 00	02 22	00 00	
Tint	Get		BE EF 03 06 00	49 73	02 00	03 22	00 00	
	Increment		BE EF 03 06 00	2F 73	04 00	03 22	00 00	
	Decrement		BE EF 03 06 00	FE 72	05 00	03 22	00 00	
BNC	Set	RGB	BE EF 03 06 00	C2 D7	01 00	11 20	00 00	
		Component	BE EF 03 06 00	52 D6	01 00	11 20	01 00	
	Get		BE EF 03 06 00	F1 D7	02 00	11 20	00 00	
Video Format	Set	Auto	BE EF 03 06 00	9E 75	01 00	00 22	0A 00	
		NTSC	BE EF 03 06 00	FE 71	01 00	00 22	04 00	
		PAL	BE EF 03 06 00	6E 70	01 00	00 22	05 00	
		SECAM	BE EF 03 06 00	6E 75	01 00	00 22	09 00	
		NTSC 4.43	BE EF 03 06 00	5E 72	01 00	00 22	02 00	
		M-PAL	BE EF 03 06 00	FE 74	01 00	00 22	08 00	
	N-PAL	BE EF 03 06 00	0E 71	01 00	00 22	07 00		
Get		BE EF 03 06 00	0D 73	02 00	00 22	00 00		
HDTV	Set	1080i	BE EF 03 06 00	F2 73	01 00	05 22	00 00	
		1035i	BE EF 03 06 00	62 72	01 00	05 22	01 00	
	Get		BE EF 03 06 00	C1 73	02 00	05 22	00 00	

## Command data chart (continued)

Names	Operation type		Header				Command data								
							CRC	Action	Type	Setting code					
Sync on G	Set	off	BE	EF	03	06	00	CB	D0	01	00	08	30	01	00
		on	BE	EF	03	06	00	5B	D1	01	00	08	30	00	00
	Get	BE	EF	03	06	00	68	D1	02	00	08	30	00	00	
PinP Size	Set	off	BE	EF	03	06	00	FE	22	01	00	00	23	00	00
		Large	BE	EF	03	06	00	6E	23	01	00	00	23	01	00
		Small	BE	EF	03	06	00	9E	23	01	00	00	23	02	00
	Get	BE	EF	03	06	00	CD	22	02	00	00	23	00	00	
PinP Position	Set	Upper left	BE	EF	03	06	00	02	23	01	00	01	23	00	00
		Upper right	BE	EF	03	06	00	92	22	01	00	01	23	01	00
		Bottom left	BE	EF	03	06	00	62	22	01	00	01	23	02	00
		Bottom right	BE	EF	03	06	00	F2	23	01	00	01	23	03	00
	Get	BE	EF	03	06	00	31	23	02	00	01	23	00	00	
PinP Audio ch	Set	RGB	BE	EF	03	06	00	BA	22	01	00	03	23	00	00
		Video	BE	EF	03	06	00	2A	23	01	00	03	23	01	00
	Get	BE	EF	03	06	00	89	22	02	00	03	23	00	00	
PinP Input	Set	Video	BE	EF	03	06	00	D6	22	01	00	02	23	01	00
		S-Video	BE	EF	03	06	00	26	22	01	00	02	23	02	00
	Get	BE	EF	03	06	00	75	23	02	00	02	23	00	00	
WHISPER	Set	NORMAL	BE	EF	03	06	00	3B	23	01	00	00	33	00	00
		WHISPER	BE	EF	03	06	00	AB	22	01	00	00	33	01	00
	Get	BE	EF	03	06	00	08	23	02	00	00	33	00	00	
GAMMA	Set	NORMAL	BE	EF	03	06	00	C7	F0	01	00	A1	30	00	00
		CINEMA	BE	EF	03	06	00	57	F1	01	00	A1	30	01	00
		DYNAMIC	BE	EF	03	06	00	A7	F1	01	00	A1	30	02	00
	Get	BE	EF	03	06	00	F4	F0	02	00	A1	30	00	00	
Over Scan	Set	Large	BE	EF	03	06	00	C2	71	01	00	09	22	02	00
		Middle	BE	EF	03	06	00	32	71	01	00	09	22	01	00
		Small	BE	EF	03	06	00	A2	70	01	00	09	22	00	00
	Get	BE	EF	03	06	00	91	70	02	00	09	22	00	00	
MyScreen Size	Set	Full	BE	EF	03	06	00	43	D6	01	00	12	30	00	00
		X1	BE	EF	03	06	00	D3	D7	01	00	12	30	01	00
	Get	BE	EF	03	06	00	70	D6	02	00	12	30	00	00	
MyScreen Lock	Set	off	BE	EF	03	06	00	3B	EF	01	00	C0	30	00	00
		on	BE	EF	03	06	00	AB	EE	01	00	C0	30	01	00
	Get	BE	EF	03	06	00	08	EF	02	00	C0	30	00	00	
Lamp Time	Get	BE	EF	03	06	00	C2	FF	02	00	90	10	00	00	
Filter Time	Get	BE	EF	03	06	00	C2	F0	02	00	A0	10	00	00	
IR Remote Front	Set	off	BE	EF	03	06	00	FF	32	01	00	00	26	00	00
		on	BE	EF	03	06	00	6F	33	01	00	00	26	01	00
	Get	BE	EF	03	06	00	CC	32	02	00	00	26	00	00	
IR Remote Rear	Set	off	BE	EF	03	06	00	03	33	01	00	01	26	00	00
		on	BE	EF	03	06	00	93	32	01	00	01	26	01	00
	Get	BE	EF	03	06	00	30	33	02	00	01	26	00	00	
IR Remote Top	Set	off	BE	EF	03	06	00	47	33	01	00	02	26	00	00
		on	BE	EF	03	06	00	D7	32	01	00	02	26	01	00
	Get	BE	EF	03	06	00	74	33	02	00	02	26	00	00	

## **LEGAL INFORMATION**

### **FIVE-YEAR LIMITED WARRANTY**

This Dukane LCD projector is warranted to the original purchaser for a period of five (5) years from the original purchase date - in normal use and service - against defects in material and workmanship. DUKANE CORPORATION EXPRESSLY DISCLAIMS ALL OTHER WARRANTIES OF MERCHANTABILITY AND FITNESS FOR A PARTICULAR PURPOSE.

During the warranty period, Dukane Corporation will repair or replace (at the manufacturer's option) any such defective parts (except for the lamp, which is subject to whatever warranties the manufacturer may provide) without charge to the purchaser for parts or labor when the product is returned, prepaid and insured, with proof-of-purchase date. This remedy is void if the product has been damaged by accident, unreasonable use, neglect, improper service or other causes not arising out of defects in material or workmanship.

Dukane Corporation disclaims all liability for incidental or consequential damage of any kind, including all damages arising out of any interruptions in operation of the product and all damages to software.

No person, firm, or representative is authorized to assume any obligation or to make any warranty on behalf of the Dukane Corporation other than as stated above.

**THIS LIMITED WARRANTY IS VALID FOR U.S.A AND CANADA.  
FOR OTHER LOCATIONS, LOCAL WARRANTIES APPLY.**

### **LAMP REPLACEMENT SERVICE & REPAIR POLICY & PROCEDURE**

For service and parts, contact the Dukane AV Service Department at 1 (800) 676-2487 within the USA or 1 (630) 584-2300 worldwide. If you would like to send a facsimile (FAX), dial 1 (630) 584-5156 worldwide.

When requesting warranty service, please have the sales receipt available along with the model name and serial number.

If it becomes necessary to return the projector, use the original packing material and box (if retained) or pack securely. Dukane Corporation will not be liable for any pick-up or delivery charges or any expenses incurred for service calls or service supplied by anyone other than the Dukane AV Service Department.

Audio Visual Products

---

Dukane Corporation  
Audio Visual Products Division  
2900 Dukane Drive  
St. Charles, IL 60174-3395  
E-mail: [avsales@dukane.com](mailto:avsales@dukane.com)

Phone: (630) 584-2300  
Orders: (800) 676-2485  
Information: (800) 676-2486  
Fax: (630) 584-5156  
Parts & Service: (800) 676-2487  
Fax: (630) 584-0984

***DUKANE***

Part # 401-598-00